



Intelligent Block Upconverter (IBUC) Operation Manual

No part of this manual may be reproduced, transcribed, translated into any language or transmitted in any form whatsoever without the prior written consent of Terrasat Communications, Inc.

© Copyright 2006 Terrasat Communications, Inc.

O&M – 10770-0001
Revision A

235 Vineyard Court, Morgan Hill, CA 95037 Phone: 408-782-5911 Fax: 408-782-5912
www.terrasatinc.com

24-hour Tech Support: 408-782-2166

Table of Contents

1. Introduction	
Overview	1-1
Reference documents	1-2
Furnished Items.....	1-4
Storage Information	1-6
Warranty Information	1-6
Warranty Policy	1-8
2. IBUC Systems: Description	
Functional Description	2-1
System Configurations	2-2
System Block Diagrams	2-3
3. IBUC Systems: Component Descriptions	
Intelligent Block Upconverter (IBUC)	3-1
Low Noise Block Converter (LNB)	3-4
Power Supply Units (PSUI)	3-5
Interface Unit (IFU)	3-5
Software	3-7
4. IBUC Systems: Installation and Setup	
Unpacking	4-1
Installing the Outdoor Unit (ODU).....	4-1
Installing the Indoor IFU	4-4
System Cabling Requirements	4-5
Grounding.....	4-12
System Alignment and Operation	4-14
Final Checks.....	4-16
5. IBUC Systems: Service and Maintenance	
Service and Maintenance	5-1
Fault Isolation	5-1
6. IBUC Systems: M&C Functions	
Description of Operation	6-1
Multi-Function LED	6-1
Hand Held Terminal.....	6-2
Frequency Shift Key Link.....	6-4
RS 485	6-5
TCP/IP	6-11
Embedded Web Pages.....	6-28
Power Measurement	6-36

7. IBUC Redundant Systems

Introduction.....	7-1
Description.....	7-1
Component Descriptions	7-3
Installation and Setup	7-8
System Alignment and Operation	7-21
Final Checks.....	7-23
M&C Setup	7-24
Service and Maintenance	7-32
M&C Functions	7-35
Embedded Web Pages.....	7-57

8. Glossary

Glossary of Terms.....	8-1
------------------------	-----

9. Component Specifications and Reference Drawings

C-Band IBUC Specifications.....	9-2
Ku-Band IBUC Specifications	9-4
Outdoor Power Supply Specifications	9-6
Interface Unit Specifications.....	9-8
1+1 Protection System Specifications	9-10

Reference Drawings:

5/10W C-band IBUC Outline Drawing, Waveguide Output
5/10W C-band IBUC Outline Drawing, N-Type Output
20/25W C-band IBUC Outline Drawing, N-Type Output
20/25W C-band IBUC Outline Drawing, Waveguide Output
40W C-band IBUC Outline Drawing, N-type Output
40/80W C-band IBUC Outline Drawing, Waveguide Output
2-8W Ku-band IBUC Outline Drawing
12W Ku-band IBUC Outline Drawing
16/20W Ku-band IBUC Outline Drawing
2-8W Full Ku-band IBUC Outline Drawing
16/20W Full Ku-band IBUC Outline Drawing
25-40W Full Ku-band IBUC Outline Drawing
C-band LNB Outline Drawing
Ku-band LNB Outline Drawing
400W PSUI Outline Drawing
700W PSU Outline Drawing
IFU Outline Drawing
C-Band 1+1 Outline Drawings (6 Sheets)
Ku-Band 1+1 Outline Drawings (4 Sheets)
RX 1+1 Interface Assembly Outline Drawing
PSUI, IDU, 200W, Dual Power Supply Outline Drawing

FIGURES

Figure 2-1 Low Power System Configuration	2-3
Figure 2-2 High Power System Configuration.....	2-4
Figure 2-3 Low Power System Configuration with IFU	2-5
Figure 3-1 IBUC Block Diagram	3-3
Figure 3-2 LNB Block Diagram	3-4
Figure 3-3 IFU, Tx/Rx, Block Diagram.....	3-6
Figure 4-1 IBUC Front Panel	4-5
Figure 4-2 PSUI Front Panel.....	4-8
Figure 4-3 IFU Back Panel.....	4-10
Figure 6-1 IBUC Hand Held Terminal.....	6-3
Figure 6-2 IBUC Hand Held Terminal Menu Tree.....	6-4
Figure 6-3 Login Web Page.....	6-29
Figure 6-4 Alarm Status Web Page	6-30
Figure 6-5 Transmit Status Web Page	6-31
Figure 6-6 Transmit Config Web Page	6-32
Figure 6-7 Interface Config Web Page	6-33
Figure 6-8 System Config Web Page	6-34
Figure 6-9 Alarm Config Web Page.....	6-35
Figure 6-10 Burst Power Measurement.....	6-37
Figure 7-1 IBUC Redundant System	7-2
Figure 7-2 TX 1+1 Interface Module Block Diagram.....	7-4
Figure 7-3 RX 1+1 Interface Module Block Diagram	7-6
Figure 7-4 TX 1+1 Interface Module Top View	7-12
Figure 7-5 RX 1+1 Interface Module Front Panel	7-16
Figure 7-6 RX 1+1 Interface Module Back Panel	7-16
Figure 7-7 RX 1+1 Interface Module Side View.....	7-16
Figure 7-8 IBUC Hand Held Terminal.....	7-37
Figure 7-9 RX 1+1 Hand Held Terminal Menu Tree	7-38
Figure 7-10 IBUC 1+1 M&C Web Page.....	7-57
Figure 7-11 RX 1+1 Login Web Page.....	7-58
Figure 7-12 Network Config Web Page	7-59
Figure 7-13 Alarm Config Web Page.....	7-60
Figure 7-14 Threshold Config Web Page	7-61
Figure 7-15 Alarm Status Web Page	7-62
Figure 7-16 Sensor Status Web Page	7-63
Figure 7-17 Alarm Control Web Page.....	7-64
Figure 7-18 Redundant Control Web Page	7-65

TABLES





Table 1-1 Reference Documents	1-2
Table 2-1 Transmit Frequency Plans.....	2-1
Table 2-2 Receive Frequency Plans.....	2-2
Table 4-1 IBUC Connector Schedule	4-6
Table 4-2 IBUC M&C Connector J2, Pin Assignments	4-7

Table 4-3 IBUC Power Connector J3 Pin Assignments.....	4-8
Table 4-4 PSUI Connector Schedule.....	4-9
Table 4-5 PSUI AC Power Connector J1 Pin Assignments	4-9
Table 4-6 PSUI DC Output Connector J2, Pin Assignments	4-9
Table 4-7 PSUI Fan Connection Pin Assignments	4-10
Table 4-8 IFU Connector Schedule	4-10
Table 4-9 Recommended Test Equipment	4-14
Table 6-1 LED Alarms	6-2
Table 6-2 IBUC Data Packet Byte Configuration	6-6
Table 6-3 Table of BUC Commands.....	6-7
Table 6-4 Response to BUC Commands 0x01, 0x02, 0x03, 0x04, and 0x08	6-8
Table 6-5 Response to BUC Commands 0x05, 0x06 (when Data Byte 1 of command message =0x00)	6-9
Table 6-6 Response to BUC Command 0x06 (when Data Byte 1 of command message=0x01)	6-9
Table 6-7 Response to command 0x07.....	6-9
Table 6-8 Response to command 0x09.....	6-10
Table 6-9 IBUC M&C Command Set.....	6-12
Table 6-10 Alarm Flags	6-28
Table 7-1 1+1 Interface Module.....	7-13
Table 7-2 RS232, HHT & Alarm Connectors J1 and J8 Pin Assignments	7-14
Table 7-3 M&C Interface Connectors J2 and J4, Pin Assignments	7-14
Table 7-4 User Interface Connector J3, Pin Assignments	7-15
Table 7-5 RX 1+1 Interface Module.....	7-17
Table 7-6 User Interface Connector J1, Pin Assignments	7-18
Table 7-7 Power Connectors J2 and J3, Pin Assignments	7-18
Table 7-8 “Y” Adapter Connector Schedule.....	7-19
Table 7-9 Recommended Test Equipment	7-21
Table 7-10 RX 1+1 Command Set.....	7-41
Table 7-11 Alarm Flags	7-56

Warnings

Failure to observe all Warnings and Cautions may result in personnel injury and/or equipment damage not covered by the warranty.

	<p><i>Follow standard Electrostatic Discharge (ESD) procedures when handling the Terrasat Equipment.</i></p>
---	---

	<i>Only factory-trained and – authorized technicians may perform any internal maintenance.</i>
	<i>Observe normal safety precautions when operating, servicing, and troubleshooting this equipment.</i>
	<i>Use care when working with high voltages.</i>
	<i>Take standard safety precautions with hand and/or power tools</i>
	<i>Ensure that it is safe to transmit prior to enabling the transmission.</i>

Cautions

!!	<i>Use care when lifting the Terrasat equipment to avoid physical injury.</i>
!!	<i>Maintain a clear airflow passage around the PSU's and the IBUC (front, back, and sides) for the fan intake and exhaust.</i>
!!	<i>Ensure that the IBUC heat sink has been mounted so that the heat may escape.</i>
!!	<i>AC transients and surges can cause data transmission errors.</i>
!!	<i>Warranty seals are designed to break upon internal access. Access to the internal electronics without written approval will void the warranty.</i>

Chapter 1 Introduction

Overview

This user manual is for use with the Terrasat Communications, Inc. C and Ku-Band Intelligent Block Upconverters (IBUC's), Power Supply Units (PSUI's), Low Noise Block Converters (LNB's), associated Interface Units (IFU's, Tx 1+1 and Rx 1+1) and accessories supplied with IBUC systems.

Intelligent Block Upconverters (IBUC's)

The C and Ku-Band IBUC's block upconvert an L-Band IF to one of four C-Band uplink frequencies or one of three Ku-band uplink frequencies. The rated power of the IBUC is specified at P1dB at the output waveguide flange or N-type connector. The IBUC comes in a single weatherproof housing suitable for antenna or feedhorn mounting. Refer to Table 2-1 for available frequency plans and power levels.

The term "Intelligent Block Upconverter" refers to the advanced features and Monitor and Control (M&C) capabilities of the IBUC product. The IBUC includes Automatic Gain Control (AGC) and Automatic Level Control (ALC) features as well as internal diagnostics. It also provides extensive monitoring and control through a menu of software commands and alarms providing access to the numerous operating parameters and features available in the unit. Access to features and M&C is provided via several methods including: Hand held terminal, RS232, RS485, TCP/IP and FSK link via the IFL cable. The IBUC is also fitted with a multi-function LED for visual status indications.

Power Supply Units (PSUI's)

The PSUI converts the universal AC input (100-240VAC) to 24 or 48 VDC, depending on the option ordered, to power the IBUC. The power supply is available in two versions: indoor rack-mount and outdoor types. The 200W hot-swappable dual Power Supply (indoor rack-mount) is housed in a Standard 1RU (19 inches rack) and powers Low Power Tx and Rx Redundant Systems. The outdoor PSUI comes in a single weatherproof housing suitable for antenna mounting and can power all of the Terrasat IBUC's. There are three versions of the outdoor PSUI available: 400W 24V, 400W 48V and 700W 48V (same Power Supply as 400W 48V with external cooling fan in a fan housing).

Low Noise Block Converters (LNB's)

The C and Ku-Band LNB's block downconvert one of three C-Band downlink frequencies or one of three Ku-band downlink frequencies to an L-Band IF. The noise temperature of the LNB is specified in degrees Kelvin. The LNB comes in a

single weatherproof housing suitable for antenna feedhorn mounting. Refer to Table 2-2 for available frequency plans and noise temperature ratings.

Interface Unit (IFU)

The IFU (Interface Unit) allows the integrator to multiplex a 10MHz reference, a DC voltage (24V or 48V) for Low Power IBUC's, as well as 24V DC supply for the LNB, onto the IFL that connects the Modem to the IBUC and LNB. The IFU comes in a variety of configurations to fulfill customer specific needs.

Interface for Redundant Systems (Tx 1+1 and Rx 1+1)

The Tx 1+1 Interface module is a passive unit. This module divides the FSK, 10MHz reference and L-Band signals, as well as routes the Ethernet connection to the IBUC's through an Ethernet switch. It supports various interface connectors and includes a bank of LEDs for visual indication of alarm conditions. The user interface may be through any of the following: via web browser to embedded web pages, TCP/IP through Telnet session, handheld terminal, RS232, RS485, as well as FSK link to both IBUC's.

The Rx 1+1 Interface is a separate outdoor Rx interface module that is powered by the IBUC power supplies and performs all required functions for redundant operation of LNB's. No indoor controller is necessary. The user interface may be through any of the following: via web browser to embedded web pages, TCP/IP through Telnet session, handheld terminal, RS232, or RS485. It also includes a bank of LEDs for visual indication of alarm conditions.

This manual provides information on:

- How to install, operate, maintain and troubleshoot the IBUC's, Power Supply Units, Interface Units and Redundant Systems.
- How to use the user interface protocols for remote monitor and control capabilities of the IBUC and Redundant Systems.

Reference Documents

Table 1-1 Reference Documents

Earth station Standards	
Intelsat IESS 309	Performance Characteristics for Intermediate Data Rate Digital Carriers Using Convolutional Encoding and QPSK Modulation
Eutelsat EESS 502	Minimum Technical and Operational Requirements for Earth Stations Transmitting to a Eutelsat Transponder for Non-Standard Structured Types of SMS Transmissions.

	Standard M.
ETS 300-332	Satellite Earth Stations (SES); Transmit-only or transmit-and-receive Very Small Aperture Terminals (VSATs) used for communications operating in the Fixed Satellite Service (FSS) 6 GHz and 4 GHz frequency bands.
ETS 300-159	Satellite Earth Stations (SES); Transmit/receive Very Small Aperture Terminals (VSATs) used for data communications operating in the Fixed Satellite Service (FFS) 11/12/14 GHz frequency bands.
ETS 300-160	Satellite Earth Stations (SES); Control and monitoring functions for VSAT networks.
ETSI EN 301 428	Satellite Earth Stations and Systems (SES); Harmonized EN for Very Small Aperture Terminal (VSAT); Transmit-only, transmit/receive or receive only satellite earth stations operating in the 11/12/14 GHz frequency bands covering essential requirements under article 3.2 of the R&TTE directive.
ETSI EN 301 443	Satellite Earth Stations and Systems (SES); Harmonized EN for Very Small Aperture Terminal (VSAT); Transmit-only, transmit-and-receive, receive-only satellite earth stations operating in the 4 GHz and 6 GHz frequency bands covering essential requirements under article 3.2 of the R&TTE Directive.
Environmental Standards	
ETS 300 019-1-1	Equipment Engineering (EE): Environmental Conditions and Environmental Tests for Telecommunications Equipment. Part 1-1: Classification of environmental conditions. Storage.
ETS 300 019-1-2	Equipment Engineering (EE): Environmental Conditions and Environmental Tests for Telecommunications Equipment. Part 1-2: Classification of environmental conditions. Transportation.
ETS 300 019-1-4	Equipment Engineering (EE): Environmental Conditions and Environmental Tests for Telecommunications Equipment. Part 1-4: Classification of environmental conditions. Stationary use at non-weather protected locations.
EMC/EMI Standards	
99/5/EEC	The Radio and Telecommunications Terminal Equipment Directive
EN 301 489-12 v1.2.1	Electromagnetic Compatibility and Radio Spectrum Matters (ERM); Electromagnetic Compatibility (EMC) standard for radio equipment and services; Part 12: Specific conditions for Very Small Aperture Terminal, Satellite Interactive Earth Stations operated in the frequency ranges between 4 GHz and 30 GHz in the

	Fixed Satellite Services (FSS)
EN 55022A	Measurement of Radio Disturbance Characteristics
EN 61000-3-2/3	Electromagnetic Compatibility (EMC)
Safety Standards	
73/23/EEC	The Low Voltage Directive
EN 60950-1	Information technology equipment – Safety -

Furnished Items

Intelligent Block Upconverters (IBUC's)

- A C-band or Ku-Band Intelligent Block Up-Converter (IBUC) with an integrated SSPA
- Operating Manual in CD-ROM format
- WG Gaskets and Hardware (WG Units Only)
- Mounting Bracket (optional)
- Mounting Bolts
- Test datasheet and Certificate of Conformance
- Quick Setup Guide

Power Supply Units (PSUI's)

- **Indoor PSUI:**
 - A Single or Dual 200W Indoor Power Supply Unit (PSUI)
 - A mating DC connector for the indoor PSUI
 - Mounting Hardware
 - AC Cable
 - Spare Fuses
- **Outdoor PSUI:**
 - A 400W Power Supply Unit
 - A DC cable to interconnect to IBUC
 - Mounting Bracket (optional)
 - Mounting Bolts
 - Mating AC Connector
 - Spare Fuses
 - A 700W Power Supply Unit
 - A DC cable to interconnect to IBUC
 - Mounting Bracket (optional)

- Mounting Bolts
- Mating AC Connector
- Spare Fuses

Low Noise Block Converters (LNB's)

- A C-band or Ku-band LNB (optional)
- WG Gasket and Hardware

Interface Unit (IFU)

- An Interface Unit
- Mounting Hardware
- AC Power Cord
- Spare Fuses

Redundant Systems (Tx 1+1 and Rx 1+1)

- A 1+1 Tx Interface Module
- A Waveguide Switch and WG pieces (C-band or Ku-band)
- Mounting plate with brackets (optional)
- BUC Interface cables (L-Band and M&C)
- Switch cable
- Power Supply Mounting Kit (optional)
- M&C Mating Connector
- Operating Manual in CD-ROM format
- Quick Setup Guide

- A 1+1 Rx Interface Module
- A Waveguide Switch (C-band or Ku-band)
- WG Pieces for Ku-band LNB Mounting
- M&C Mating Connector
- Mounting Bracket & Bolts
- Mounting Plate (optional)
- DC Cables and Y-cable Adapter (optional)
- L-Band cables
- Switch cable
- Operating Manual in CD-ROM format
- Quick Setup Guide

Accessories

- A handheld terminal (optional)

- A TX reject filter - attached to the LNB (optional)
- A waveguide RX reject filter (optional)
- TCP/IP test cable (optional)
- Installation kits (optional)

Storage Information

- There are no storage limitations on the IBUC, outdoor PSUI or 1+1 Interfaces for Redundant Systems other than avoiding excessive exposure beyond the -40°C to +60°C external ambient temperature, as stated in Chapter 9, Environmental Conditions.
- There are no storage limitations on the indoor PSUI's or IFU's other than avoiding excessive exposure beyond the 0°C to +50°C external ambient temperature, as stated in Chapter 9, Environmental Conditions.

Warranty Information

- All equipment warranty shall be in accordance with the Terrasat Communications, Inc. Warranty Policy. See page 1-8.
- Returned Material Authorization (RMA)
 - If any equipment is determined to be defective:
 - Have available the following information:
 - Unit serial number
 - Unit part number and description
 - Complete description of the failure
 - Designated contact name and phone number
 - Billing information
 - Shipping information
 - Contact Terrasat Customer Service to request a RMA number. The phone number is listed on the front cover of this manual.
 - Properly package the defective equipment in its original container (if available and undamaged), and mark the RMA number on the outside of the shipping container.

- Ship the equipment to the address shown on the front cover of this manual.
- After the unit is received at Terrasat, an initial evaluation will be performed.
- If the unit is found to be in-warranty, the unit will be repaired and returned at no charge.
- If the unit is found to be out-of-warranty, Terrasat Customer Service will contact the designated contact for authorization to proceed with the repair.
- Authorization in the form of a purchase order will be required.
- Once authorization is received, the unit will be repaired and returned.



TERRASAT COMMUNICATIONS, Inc. PRODUCTS WARRANTY POLICY

(A) This warranty is for equipment of Terrasat Communications, Inc. The term "Terrasat" as used throughout this warranty shall mean Terrasat Communications, Inc, if the equipment was manufactured by Terrasat Communications, Inc.

(B) Terrasat warrants that its equipment will be free from defects in material or workmanship at the time of shipment and that it will conform to applicable specifications.

- For all Satcom products, the buyer shall exercise any and all warranty claims within a period of twenty four (24) months.
- For all Radio products, the buyer shall exercise any and all warranty claims within a period of eighteen (18) months.

(1) The warranty does not apply to any part of a product if it has been altered, repaired or misused in a way that, in the opinion of Terrasat, affects the reliability of, or detracts from the performance of any part of the product, or if it is damaged as a result of the use of such part in or in connection with equipment not previously approved by Terrasat.

(2) The warranty does not apply to any product or parts thereof if its serial number or the serial number of any of its part has been altered, defaced, or removed.

(3) The warranty does not cover damages or losses incurred in transportation.

(4) The warranty does not cover replacement or repair necessitated by loss or damage resulting from any cause beyond the control of Terrasat.

(5) The warranty does not include the furnishing of any labor involved or connected with the removal and/or reinstallation of warranted equipment or parts on site, or any labor required to diagnose the necessity for replacement or repair.

(6) IN NO EVENT SHALL TERRASAT BE LIABLE TO BUYER FOR ANY INDIRECT, SPECIAL OR CONSEQUENTIAL DAMAGES OR LOST PROFITS ARISING FROM THE USE OF THE EQUIPMENT OR PRODUCTS, EVEN IF TERRASAT HAS BEEN ADVISED OF THE POSSIBILITY THEREOF, OR FOR ANY INABILITY TO USE THEM EITHER SEPARATED FROM OR IN COMBINATION WITH ANY OTHER EQUIPMENT OR PRODUCTS.

(C) **TERRASAT'S WARRANTY, AS STATED HEREIN, IS IN LIEU OF ALL OTHER WARRANTIES, EXPRESSED, IMPLIED, OR STATUTORY, INCLUDING THOSE OF MERCHANTABILITY AND FITNESS FOR A PARTICULAR PURPOSE, AND TERRASAT NEITHER ASSUMES NOR AUTHORIZES ANY PERSON TO ASSUME FOR IT ANY OTHER OBLIGATION OR LIABILITY TO ANY PERSON IN CONNECTION WITH THE SALE OR USE OF TERRASAT'S PRODUCTS.** The buyer shall pass on to any purchaser, lessees, or other user of Terrasat's products, the aforementioned warranty, and shall indemnify and hold harmless Terrasat from any claim or liability of such purchaser, lessees, or user based upon allegations that the buyer, its agents, or employees have made additional warranties or representations as to product preference or use.

(D) A fixed charge established for each product will be imposed for all equipment returned for warranty repair and where the cause of failure cannot be identified by Terrasat.

Chapter 2 IBUC Systems: Description

Functional Description

Outdoor Equipment

The Terrasat line of C-band and Ku-band Outdoor Units (ODU's) consists of a range of Intelligent Block UpConverters (IBUC's), Power Supply Units for IBUC's (PSUI's), and Low Noise BlockConverters (LNB's) for use in satellite earthstations. The outdoor equipment is designed to interface directly with an L-band satellite modem.

The Interfacility Link (IFL) between the ODU's and the L-band modem utilizes 950 to 1750 MHz (L-Band) as the interface frequency. This approach allows transmission and reception over the entire satellite band as opposed to a single transponder. The L-band IFL also carries associated signals (10MHz, DC voltage, FSK) simplifying installation and reducing costs. Terrasat IBUC's are available in C-Band or Ku-band and can be used for SCPC/MCPC, point-to-point, or point-to-multipoint network applications (voice, data, video or IP services). All outdoor units are weatherized and designed to mount outdoors, in most climates, and on most satellite earthstation antennas. Refer to Figures 2-1, 2-2 and 2-3 for typical equipment configurations.

The IBUC is available in Standard C-band, Palapa C-band, Insat C-band, Extended C-Band, Standard Ku-band, Extended Ku-band, or Full Ku-band. See Table 2-1 for actual frequencies. The IBUC houses the IF Interface (de-mux), the UpConverter (UPC), the Monitor and Control (M&C) card, a DC to DC converter and associated circuitry, and a Solid State Power Amplifier (SSPA) assembly. The 20-80 watt C-band IBUC's and the 12-40 watt Ku-band IBUC's also have an external cooling fan assembly. The input interface to the IBUC interfaces to a 50 Ω or 75 Ω (optional) coaxial cable that carries the L-Band transmit signal, 10 MHz reference oscillator signal, DC power and bi-directional M&C FSK signals.

Table 2-1 Transmit Frequency Plans

	Standard	Palapa	Insat	Extended	Standard	Extended	Full
Signal	C-band	C-band	C-band	C-band	Ku-band	Ku-band	Ku-band
L-band	950-1525MHz	1150-1450MHz	1150-1450MHz	950-1750MHz	950-1450MHz	950-1450MHz	950-1700MHz
LO fr.	7.375GHz	7.875GHz	8.175GHz	7.600GHz	13.050GHz	12.800GHz	12.800GHz
RF fr.	5.850-6.425GHz	6.425-6.725GHz	6.725-7.025GHz	5.850-6.650GHz	14.00-14.50GHz	13.75-14.25GHz	13.75-14.50GHz
Output Power	5,10,20,25,40,60, 80W	5,10,20,25,40,60, 80W	5,10,20,25,40,60, 80W	5,10,20,25,40,60, 80W	4,8,12,16,20,25,30,40W	4,8,12,16,20,25,30,40W	4,8,12,16,20,25,30,40W

The LNB is available in Standard C-band, Palapa C-band, Insat C-band, or one of three Ku-band frequency bands. See Table 2-2 for actual frequencies. The C-band LNB comes standard with a typical noise temperature of 35°K whereas the Ku-band typical noise temperature is 60°K. The LNB houses the Low Noise Amplifier (LNA), the RX conversion circuitry, and the L-band IF Interface (de-mux). The interface with the LNB

consists of a 50 or 75 Ω (optional) coaxial cable that carries the L-Band receive signal, 10 MHz reference oscillator signal, and DC power.

Table 2-2 Receive Frequency Plans

	Standard	Palapa	Insat	
<u>Signal</u>	<u>C-band</u>	<u>C-band</u>	<u>C-band</u>	<u>Ku-band</u>
RF fr.	3.625-4.200GHz	3.400-4.200GHz	4.500-4.800GHz	10.95-11.70GHz or 11.70-12.20GHz or 12.25-12.75GHz
L-band Out fr.	950-1525MHz	950-1750MHz	960-1260MHz	950-1700MHz or 950-1450MHz
Noise temperature	35°K	35°K	35°K	60°K

The PSUI converts the universal AC input (100-240VAC) to 24VDC or 48 VDC to power the IBUC. The 400W outdoor PSUI comes in a single weatherproof housing suitable for antenna mounting and can power 5-40W C-band and 4-25W Ku-band IBUC's. The 700W outdoor PSUI comes in a single weatherproof housing suitable for antenna mounting. The 700W PSUI includes a cooling fan and a fan housing and can power 60-80W C-band and 30-40W Ku-band IBUC's.

Indoor Equipment

The indoor IFU (Interface Unit) allows the integrator to multiplex a 10MHz reference, a DC voltage (24V or 48V) for Low Power IBUC's (up to 12W Output Power), as well as 24V DC supply for the LNB, in case the Modem doesn't offer these features. Any combination can be configured at the factory; for example, IBUC Supply only, 10 MHz reference only, both IBUC Supply and 10 MHz, etc. The IFU also provides a pass for the FSK signal, allowing the Modem to communicate with IBUC. The IFU is housed in a 1RU rack mount (19 inches) and has to be connected between the Modem and the IBUC and LNB.

System Configurations

Figures 2-1, 2-2 and 2-3 show typical earth station installations using Terrasat transceivers. In normal operation the IBUC, the LNB, and the PSUI are mounted outdoors on the antenna. The IBUC and the LNB can interface directly to a satellite modem, a 70MHz to L-band rackconverter, a modem combiner network, or an IFU. In any case, the indoor unit must provide the 10MHz for the LNB and the IBUC, the DC voltage for the LNB, and the TX L-band signal for the IBUC. The modem may supply the DC voltage via the IFL cable to the IBUC (4-12Watt units). In addition, the indoor equipment will receive the RX L-band signal from the LNB.

Monitor and Control (M&C) is available via an FSK signal (through the IFL) or through a separate cable for either RS-232, RS-485 or TCP/IP. A Hand Held Terminal is available for local M&C. Refer to chapter 6 for actual M&C capabilities and commands for the IBUC.

Certain considerations must be taken when selecting the IFL since appropriate shielding and signal levels are required for normal system operation. The IBUC is designed to operate with a -30 dBm TX L-band input signal to achieve rated power at maximum gain. The IBUC provides a user accessible variable attenuator that allows the gain of the unit to be reduced by up to 16dB in 0.1dB steps. The attenuator can be used to prevent overdrive to IBUC in configurations with a short cable run (IFL) and thereby preserving Modem dynamic range. In addition the IBUC and LNB must have a 10MHz input signal, at $+3$ to -12 dBm for the IBUC, and 0 to -10 dBm for the LNB. The maximum voltage drop for a 24VDC BUC is 4 volts and for a 48VDC BUC is 11 volts.

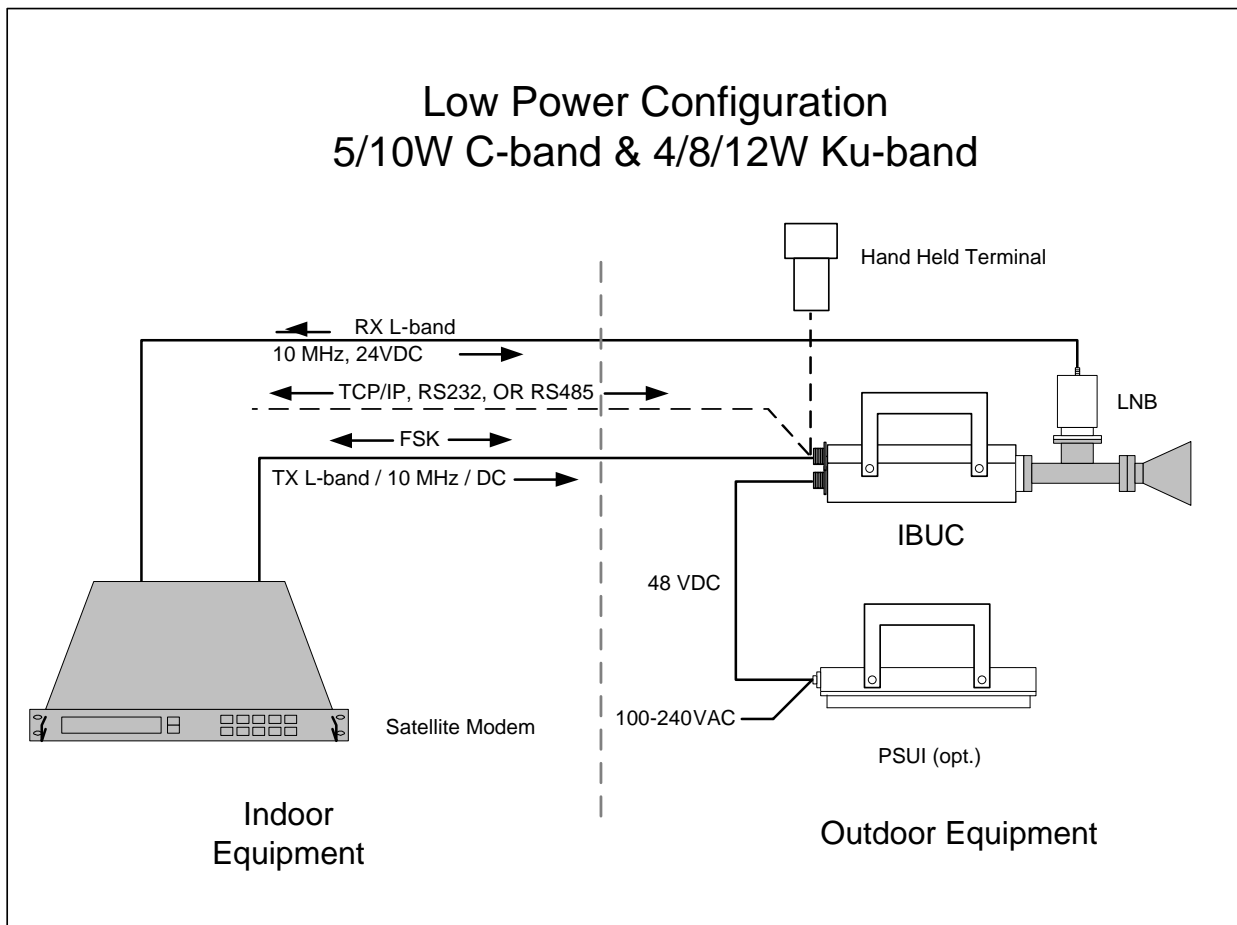

Note: 12W IBUC has a cooling fan

Figure 2-1 Low Power System Configuration

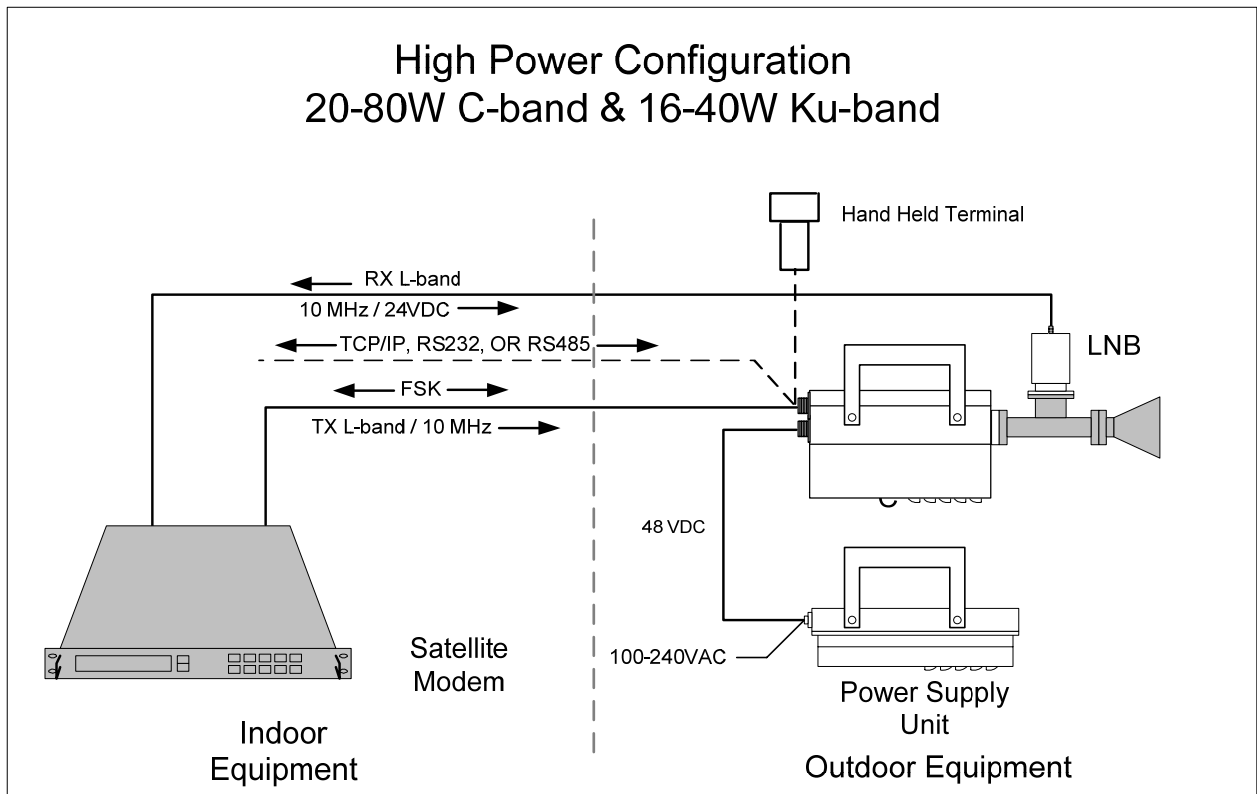

Note: PSUI could be -548 or -648 (with cooling fan)

Figure 2-2 High Power System Configuration

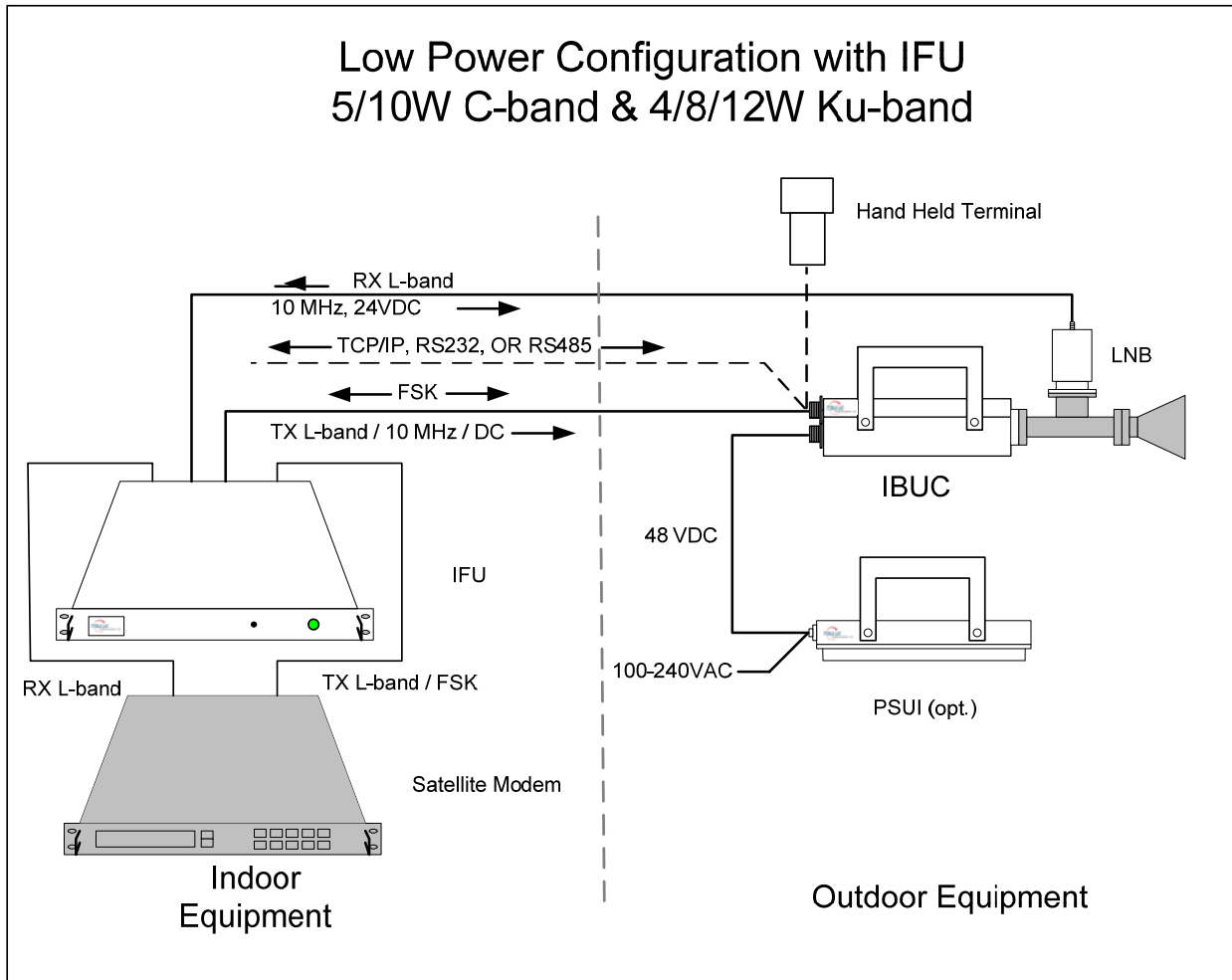

Note: 12W IBUC has a cooling fan

Figure 2-3 Low Power System Configuration with IFU

Chapter 3 IBUC Systems: Component Descriptions

As described in earlier chapters the ODU consists of an Intelligent Block Upconverter (IBUC) and could include a Power Supply Unit for IBUC's (PSUI) and / or a Low Noise Blockconverter (LNB). The indoor IFU may also be part of the configuration. This chapter explains the functionality of each component and their interrelationships. Refer to chapter 9 for the specifications of each of the components.

Intelligent Block Up-Converter (IBUC)

The IBUC is the heart of the Terrasat ODU. The IBUC comes in a variety of frequency band and power level configurations. The IBUC is available in Standard C-band, Palapa C-band, Insat C-band, Extended C-band, Standard Ku-band, Extended Ku-band and Full Ku-band. The C-band IBUC is available in 5, 10, 20, 25, 40, 60, and 80 watt configurations. The Ku-band IBUC is available in 4, 8, 12, 16, 20, 25, 30 and 40 watt configurations. The IBUC houses the IF Interface (de-mux), the Upconverter (UPC), the Monitor and Control (M&C) card, a DC to DC converter and associated circuitry, and a Solid State Power Amplifier (SSPA) assembly. The 20-80 watt C-band IBUC's and the 12-40 watt Ku-band IBUC's also have an external cooling fan assembly. The interface with the IBUC is through a 50 Ω or 75 Ω (optional) coaxial cable that carries the L-Band transmit signal, 10 MHz reference oscillator signal, DC power and bi-directional M&C FSK signals. The IBUC also comes standard with an M&C port for TCP/IP, RS-232, RS-485, and Hand Held Terminal access. The IBUC also provides a status alarm output (Form-C relay). A multi-function LED is installed on the IBUC to provide visual status indications.

Refer to the IBUC block diagram on page 3-3.

DC Supply

For lower power units (12W and below) DC power can be applied through the L-band input N-connector or F-connector (J1) or through the external power connector (J3). DC power for the higher power units (16W and above) is applied through the DC input 6-pin circular connector (J3). The high power units cannot accept the DC input through the L-band input N-connector or F-connector (J1) due to the higher current draw. In all cases the DC power input source is automatically sensed and protected so that an input to one connector does not result in an output to the other connector. If for some reason a DC power source is applied to both connectors simultaneously the protection circuitry prioritizes which DC power source will be utilized. The priority connector is the DC input 6-pin circular connector (J3).

In addition to the two possible connector inputs for the DC supply there are also options for the DC supply voltage. For lower power units (10W and below), options for 24VDC or 48VDC supplies are available. The operating voltage range for the 24VDC option is 20 to 28VDC whereas the operating voltage range for the 48VDC option is 37 to 60VDC. This option must be selected at the time of order. For all higher power units (12W and above) the standard configuration is 48VDC.

Monitor and Control

The IBUC is equipped with extensive monitor and control (M&C) capabilities. There are five ways to remotely access the M&C capabilities of the IBUC. First is via the M&C 19-pin circular connector (J2) utilizing two wire RS485. In order to access the RS485, a separate cable must be run and connected to J2. A second way to access the M&C is through the same J2 connector using RS-232. In order to access the RS-232, a separate cable must be run and connected to J2. A third way to access the M&C is through the same J2 connector using TCP/IP. This method requires a separate Ethernet cable. The fourth method is through the same J2 connector using an optional handheld terminal. The fifth way to access the M&C capabilities remotely is through the L-band input N-connector or F-connector (J1) utilizing Frequency Shift Keying (FSK). Using this method requires no additional cable but does require that the FSK be multiplexed onto the L-band cable. Certain modem manufacturers offer built in FSK capabilities capable of communicating with the IBUC through the L-band IFL. Refer to chapter 6 for specific information on command structure and commands.

RF Signal Flow

The L-band input to the IBUC is through the input N-connector or F-connector J1. The required inputs to the IBUC consist of a 10MHz sinewave signal between +3 and -12 dBm as well as the L-band signal at less than or equals to -20 dBm. In addition to the 10MHz level requirements, the 10MHz signal must meet minimum phase noise requirements (see chapter 9). The J1 input may also include a DC voltage and/or FSK signal as described above. The input from J1 is routed to the demultiplexer circuitry where the various signals are split off and routed to the appropriate circuits within the IBUC. The DC voltage is routed to the DC/DC power supply and the FSK signal is routed to the M&C card.

The 10MHz signal is routed to the multiplier circuitry where its level is first detected to provide alarm when it's low and then multiplied to a proper frequency used for phase-locking purposes. The output of the multiplier is routed to the phase detector circuitry where it is compared with the phase of the DRO (Dielectric Resonator Oscillator) signal sample and consequently generates a voltage that is applied as a control voltage to the DRO to adjust its frequency. The DRO has been optimized for phase noise at a single frequency based on the frequency band of the IBUC that has been ordered. The output of the DRO is amplified and routed to the mixer.

The L-band signal that is split off in the demultiplexer circuitry is first filtered and a sample of it is detected for M&C purposes. The signal is then amplified, and goes through two sections of Variable attenuators. The first one is used to provide a gain adjustment of 16 dB in 0.1 dB steps to the user. The second one is used to provide ALC (Automatic Level Control) or AGC (Automatic Gain Control).

After a few more sections of amplification and filtering the signal is routed to the mixer. The mixer mixes the L-band signal with the DRO signal to “upconvert” to the appropriate RF signal based on the frequency band of the IBUC. The RF signal is then filtered, amplified and routed to the temperature compensation circuitry. The temperature compensation circuitry has been calibrated over temperature so that the IBUC gain does not vary more than 3dB at any frequency. The signal is then routed through an isolator to the SSPA. The SSPA section then amplifies the signal which is then routed to the output through an isolator for reverse power protection. The RF output is detected for use by the M&C circuitry. The IBUC gain has been calibrated so that at maximum gain, a -30 dBm input results in rated power output (P1dB) of the IBUC. To operate at lower power levels simply reduce the input to the IBUC or simply reduce the gain of IBUC using the variable attenuator (see Commands in Chapter 6). The output of the C-band IBUC is a WR137 waveguide or N-type connector and WR75 waveguide for Ku-band.

IBUC Block Diagram

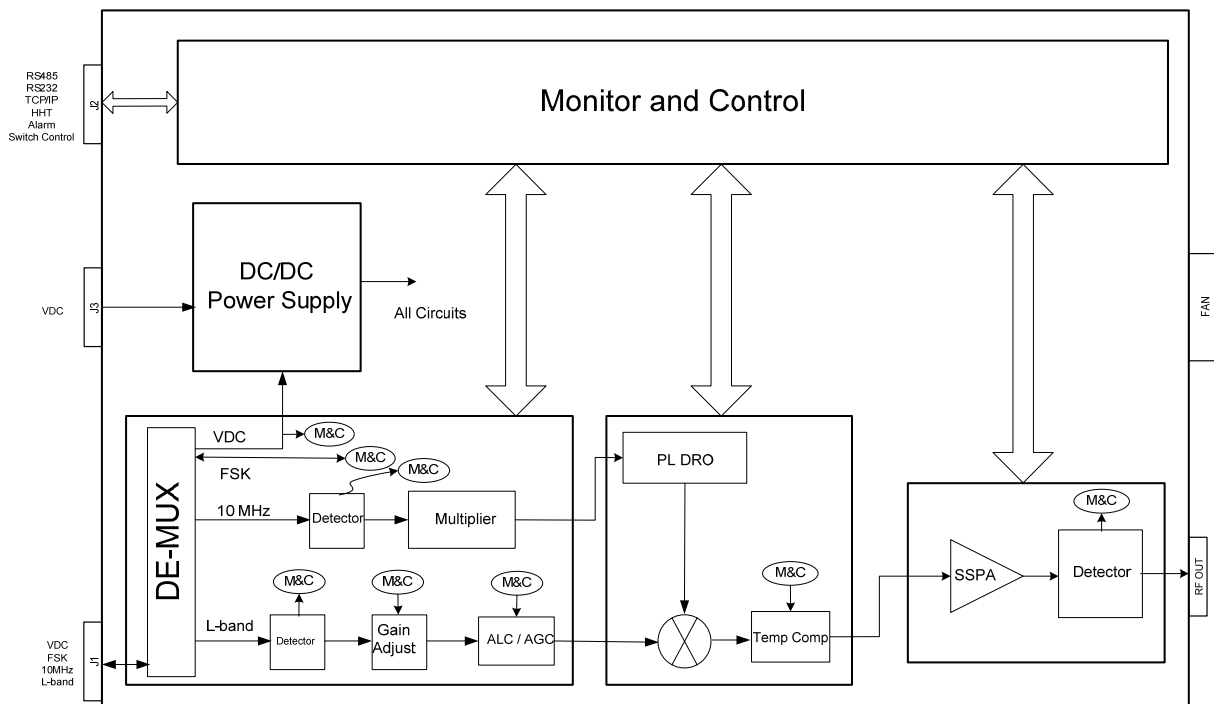

Figure 3-1 IBUC Block Diagram

Low Noise Block Converter (LNB)

The LNB is available in Standard C-band, Palapa C-band, Insat C-band or one of three Ku-band frequency bands. See Table 2-2 for actual frequencies. The C-band LNB comes standard with a typical noise figure of 35°K and the Ku-band typical noise figure is 60°K. The LNB houses the Low Noise Amplifier (LNA), the RX conversion circuitry, and the L-band IF Interface (de-mux). The interface with the LNB is through a 50 or 75 Ω coaxial cable that carries the L-Band receive signal, 10 MHz reference oscillator signal, and DC power.

Refer to LNB block diagram.

The input to the LNB is a WR229 waveguide for C-band and WR75 waveguide for Ku-band. The input to the LNB will typically be between -125 dBm and -80 dBm depending on the system design (antenna size, satellite, number of carriers, etc.). The LNB will amplify the RF input signal and downconvert it to an L-band signal. Like the IBUC the DRO is phase locked to the 10MHz signal that has been multiplexed on to the L-band output connector. The 10MHz input level must be between 0 and -10 dBm and must meet the minimum phase noise requirements (see chapter 9). The DC voltage is also multiplexed on to the L-band output connector and must be between 15 and 24VDC. Current consumption is typically less than 400mA.

LNB Block Diagram

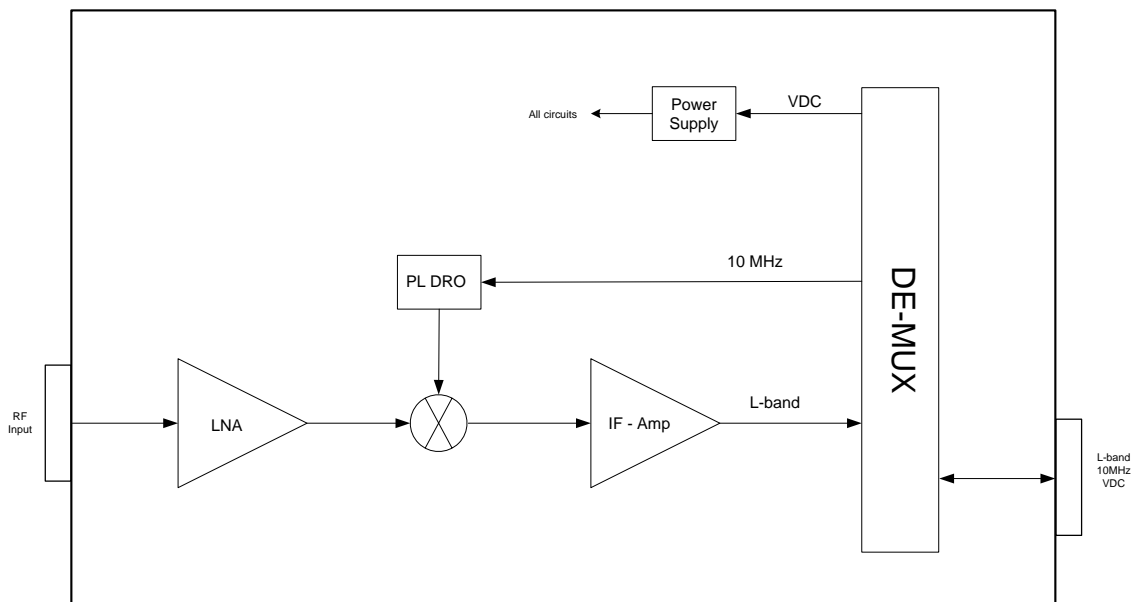

Figure 3-2 LNB Block Diagram

Power Supply Units (PSUI)

The PSUI converts the universal AC input (100-240VAC) to 24VDC (400W only) or 48 VDC to power the IBUC. The 400W outdoor PSUI comes in a single weatherproof housing suitable for antenna mounting and can power 5-40W C-band and 4-25W Ku-band IBUC's. The 700W outdoor PSUI comes in a single weatherproof housing suitable for antenna mounting. The 700W PSUI includes a cooling fan and a fan housing and can power 60-80W C-band and 30-40W Ku-band IBUC's.

400W or 700W Outdoor PSUI

The AC input to the PSUI is routed through J1 pins 2, 3 and the GND pin. Both the live and the neutral inputs are fused for maximum protection. The PSUI is designed with an autoranging power factor corrected AC to DC converter (PFC). The output of the PFC circuitry is routed to the DC to DC circuitry where it is "converted" to a 24 VDC or 48VDC voltage. The output is filtered and routed to the DC output connector J2. Due to the current requirements for the higher power IBUC's, the J2 output connector is wired with three positive and three negative connections. For the higher power IBUC's there is a PSU fan assembly that is required for additional cooling due to the higher current consumption. The fan assembly is fully external to the PSUI and can be changed without opening the PSUI. The PSUI with the fan assembly can deliver 700W at 48VDC.

An interconnecting DC cable is provided with the PSUI in addition to a mating AC input connector.

Interface Unit (IFU)

Refer to IFU block diagram on page 3-6.

The AC input to the indoor IFU (Interface Unit) is routed through an IEC power entry module. The power entry module houses a line filter, live and neutral fusing and an On/Off switch. This unit can have up to two Power Supplies internally, a 200W 24V or 48V for the IBUC and a 28W 24V for the 10MHz OCXO and LNB. The outputs of both AC/DC converters are routed to the Interface card, where they'll be multiplexed to the L-Band to feed the IBUC and the LNB, and in case of the 28W supply, converted to 12VDC to feed the OCXO. On the transmit side, the signal from the modem (J1 Tx IN) is routed to the de-multiplexer where all signals are split off (DC Supply IN, FSK, 10MHz IN, L-Band IN) and routed through separate circuits where there are a series of jumpers that allow the units to be configured, for internal or external DC supply and / or 10MHz reference, depending on customer requirements. Once selected, all these signals will be multiplexed again and routed to J2 (Tx OUT). On the receive side, the same architecture applies. On J4 (Rx IN) we have 24V OUT, 10MHz OUT and L-Band

IN. On J5 (Rx OUT) there is 24V IN, 10MHz IN and L-Band OUT. There is also one additional connector (J3) for external 10MHz input. On the front panel there is a small hole that gives access to a trimpot (when the OCXO is installed) that allows the user to adjust the frequency of the 10MHz reference. The internal 200W Power Supply can power up to 12W IBUC's. If configured with the 200W DC Supply, the chassis will be equipped with a fan. The front panel is also provided with a green LED that allows the user to verify if the unit is powered up.

IFU, Tx/Rx, Block Diagram

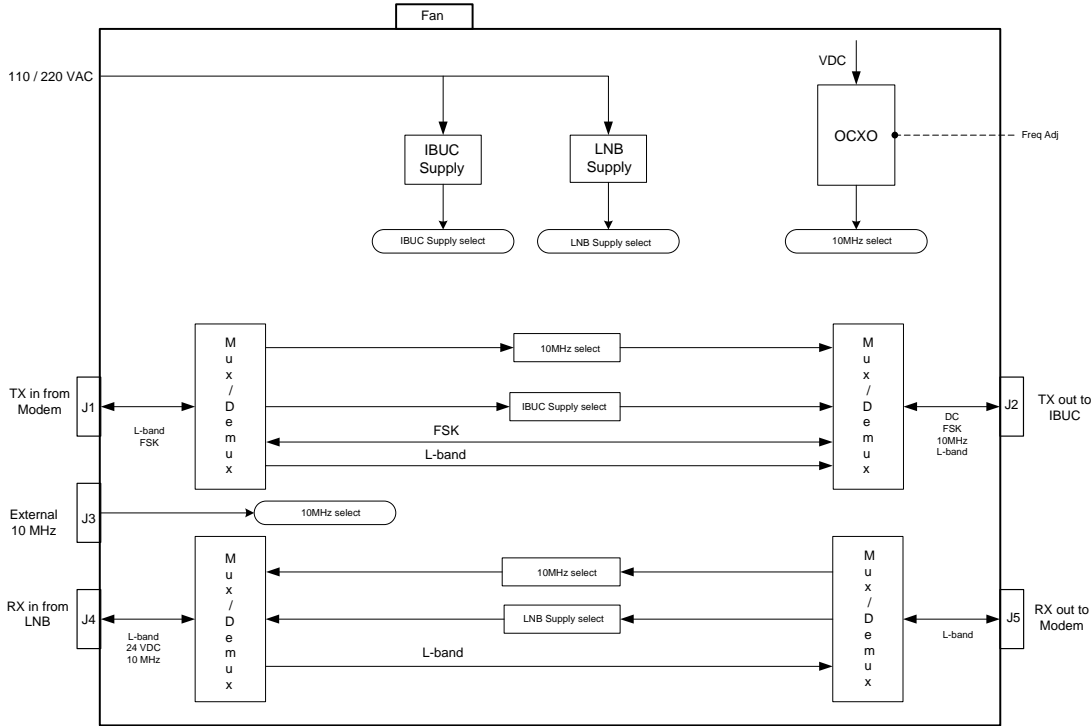

Figure 3-3 IFU, Tx/Rx, Block Diagram

Software

The IBUC monitors and controls several parameters and has features that make installation and use of the IBUC simpler as well as enhancing system performance. Refer to Chapter 6 for a full description of M&C functions.

Some of the key features include;

Monitor and Control – the IBUC may be monitored and controlled through an assortment of interfaces including RS-232, RS-485, Ethernet port, an optional handheld terminal or via an FSK link with compatible modems. The FSK link is multiplexed on the L-band IFL eliminating the need for an additional cable and simplifying installation.

Automatic Gain Control (AGC) – the IBUC continuously monitors output level. When AGC is enabled, if a change in the TX output level is detected, the input to the IBUC is checked to see if it has changed. If the input has not changed the IBUC adjusts the gain of the system in 0.1 dB steps to maintain a set gain value.

Automatic Level Control (ALC) – similar to the AGC system, when ALC is enabled the IBUC monitors output and adjusts gain to maintain a constant output level.

Redundancy – the IBUC senses automatically when configured in Redundancy. The logic for redundant operation is built-in. Eliminates the need of an external switching controller.

Embedded Webpage – provides management for small networks using a web browser.

Burst Operation – allows the user to operate in burst mode. The IBUC reports average output power of valid bursts (above burst threshold) when in burst mode.

Alarm History – a log of all alarms that occur is maintained. This simplifies troubleshooting of the system especially if an intermittent problem occurs.

Sensors – a series of internal sensors allow operator to verify performance and troubleshoot the system. Sensors include internal temperature, 10 MHz input detector, supply voltage, current consumption, PLDRO lock voltage, input level and output level.

Chapter 4 IBUC Systems: Installation & Setup

The Terrasat ODU consists of an IBUC, and could include an LNB, a PSUI and a set of interconnection cables. The Terrasat IDU consists of an IFU.

This section contains the general requirements for installation of the ODU to the antenna and the IDU between the Modem and the ODU.

WARNING:

- ***FOR PROTECTION OF PERSONNEL AND EQUIPMENT, USE CARE WHEN INSTALLING THE ANTENNA AND WHENEVER WORKING ON OR AROUND THE SYSTEM.***
- ***TAKE STANDARD SAFETY PRECAUTIONS WITH HAND AND/OR POWER TOOLS.***
- ***USE CARE IN WORKING WITH DANGEROUS VOLTAGES.***

Unpacking

Check to make sure that the ODU has not suffered damage in shipment. If damage is noticed contact Terrasat customer support.

Compare the contents of the shipping container with the packing list to ensure all items have been received. If any item is determined to be missing contact Terrasat customer support.

Retain all shipping containers for future use.

Installing the Outdoor Unit (ODU)

Tools and Test Equipment

Have on hand a standard electrician's tool kit and any tools listed in the antenna manufacturer's installation instructions.

Site Considerations

The ODU is designed to mount on the antenna. Locate and install the antenna according to instructions supplied by the antenna manufacturer. Choose an area that is free of extraneous interference from motors and electrical equipment and has a clear

line of sight from the antenna to the satellite. Lightning arrestors should be used at the site to protect personnel and equipment. Size 3/0 or 4/0 AWG stranded copper wire should be used to ground the IBUC, the PSUI and the LNB to the antenna frame and to the lightning protection ground rod. For the higher power units with an external power supply provide an isolation filter to reduce power line interference as required.

Preparation

Mounting Considerations:

Optional Mounting Brackets are available that will facilitate mounting for most antennas.

The ODU must be mounted such that:

- Sufficient support is afforded to the IBUC, the LNB and the PSUI to minimize the effects of antenna sway in strong winds.
- Air movement across the heat fins is possible.
- The fan shroud (IBUC and PSUI) is mounted so that the louvers are facing the ground.
- The fan intake and exhausts are free from any obstruction.
- The length of the PSUI cables is taken into consideration in determining the mounting location of the PSUI.

Throughout installation and during any polarization, azimuth or elevation adjustment, ensure that cables and waveguide are not crimped or pinched.

Power Requirements



Installation and connection to the line power supply must be made in compliance with applicable wiring codes and regulations.



Ensure AC power is off prior to disconnecting PSU power cord. Turn off AC power to the unit using installed circuit breaker or similar disconnecting device.



After turning AC power source off, disconnect Power Cord from PSU before servicing the unit.

For IBUC's with a rated power level of 12 watts and below the power for the IBUC may be through the L-band IFL supplied from the satellite modem or from the Terrasat indoor IFU. The IBUC DC power can also be supplied directly through the external power connector (J3). Refer to the label on the unit to determine whether 24 or 48 Volts is required. Ensure that the 24VDC input voltage is between 20 and 28VDC and that the 48VDC input is between 37 and 60VDC.

For IBUC's with a rated power of 16 watts or greater, an external power supply is required. Terrasat offers a 400W outdoor PSUI (good for all power levels up to 40W C-band or 25W Ku-band) and a 700W outdoor PSUI (good for all power levels up to 80W C-band and 40W Ku-band). Power supplies have an auto ranging AC front end that will work with both 115VAC and 230VAC.

All outdoor PSUI's are equipped with a detachable AC power connector. When connecting the AC connector to the AC source the wiring must include a 15 or 20 amp circuit breaker. A disconnect device that is readily accessible must also be provided. Any outdoor AC connection should be made using suitable connectors or boxes with an IEC protection class of at least IP65.

The outdoor PSUI is shipped with mating connectors for the AC mains power cable. In order to remain compliant with European Low Voltage Directive (EN 60950), use a power cable that meets IEC 60227 requirements such as HAR Cable Designation H03 VV-F or H03 VVH2 -F and/or others with water resistance for outdoor applications. Power cable plugs must also meet national/local standards.

If a circuit breaker is not easily accessible as a disconnecting device, the input connector will be the disconnecting device. In this case, the socket-outlet must be installed near the equipment and must be easily accessible for pluggable equipment.

NOTE: AC transients and surges can cause data transmission errors and loss of sync in the modem and/or the ODU. Proper precautions should be taken to ensure uninterrupted service.

Antenna Mounting

Mounting Brackets are available to facilitate attachment to antennas. Generic mounting instructions for the IBUC, the LNB and the PSUI are given below.

The IBUC can be mounted on the focal point, the boom arm, the antenna back structure or in the hub depending on the antenna type. The IBUC has mounting holes on both sides of the unit that can be used to attach the IBUC to the antenna. Terrasat offers an optional mounting bracket to simplify antenna mounting. Refer to chapter 9 for the mounting hole dimensions.

The PSUI will typically mount on the boom arm, the antenna back structure or the hub of an antenna. The PSUI has mounting holes on both sides of the unit that can be used

to attach the PSUI to the antenna. Terrasat offers an optional mounting bracket to simplify antenna mounting. Refer to chapter 9 for mounting hole dimensions.

The LNB is mounted directly to the OMT at the focal point of the antenna. Ensure that proper gasketing is used when mounting the LNB to the OMT.

Installing the Indoor IFU

Tools and Test Equipment

Have on hand a standard electrician's tool kit.

Mounting Location

The Terrasat IFU dimensions are 19-inch rack width, 1RU-rack high (1.75 inches), and 8.6 inches deep. Refer to chapter 9 for detailed dimensions. Allow a minimum of 6 inches (15 cm) between the back of the chassis and the end of the rack for cable clearance.

The IFU may be rack-mounted or placed on a flat surface. If the PSUI is to be rack-mounted, a rack shelf or tray is recommended.

The IFU should be positioned close to other units in the network such as the satellite modem.

Access/Airflow

Adequate space must be reserved for air movement, cable connections, and equipment access. Do not block the airflow on the sides of the chassis. Without sufficient air cooling, the unit may overheat.

Cabling/Lengths

Measure the distance between the satellite modem(s) and the IFU. You will need to provide the IF interface cable between the modem TX output and the IFU TX input, as well as the IF interface cable between the modem RX input and the IF RX output. Ensure that the cable is capable of operating at the modem frequencies.

AC Power Connection

The IFU is designed to work at 100 - 240 VAC, 47 - 63 Hz. The IFU must be grounded through the AC power cable (standard 3-prong equipment connection).

Current and voltage surges in the AC power input can be reduced by installing surge protectors and AC power line filters.

Note: AC transients and surges can cause data transmission errors.

To ensure uninterrupted service, some method of backup AC power is recommended.

An un-interruptible power supply (UPS) is preferred, along with a power stabilizer or an isolation filter to ensure clean power.

System Cabling Requirements

Cables and Connectors

IBUC, PSUI, IFU connectors and pin outs are shown in the tables below. Mating connectors are also shown. Mating connectors and/or cables may be ordered from Terrasat as optional items.

IBUC



Figure 4-1 IBUC Front Panel

Table 4-1 IBUC Connector Schedule

IBUC CONNECTOR SCHEDULE			
REF DESIG	FUNCTION	CONNECTOR	CONNECTOR MATE
J1	TX IN	TYPE-N, RCPT (TYPE-F optional)	TYPE-N PLUG (TYPE-F PLUG)
J2	M&C INTERFACE	AMPHENOL CYLINDRICAL, BOX MTG RCPT, 19S (MS3112E-14-19S)	AMPHENOL CYLINDRICAL, STRAIGHT PLUG, 19P (MS3116F-14-19P)
J3	DC POWER	CANNON MS CIRCULAR, BOX MOUNTING RCPT (MS3102R14S-6P)	CANNON MS CIRCULAR, STRAIGHT PLUG (MS3106F14S-6S)
RF OUT	Ku-Band	WR75, COVER FLANGE WITH GROOVE	WR-75 COVER FLANGE
RF OUT	C-Band	CPR137, CPRG WAVEGUIDE or N-Type (F)	CPR-137, CPRF, WAVEGUIDE or N-TYPE (M)

A mating M&C connector for J2 or DC interface connector for J3 are available from Terrasat. For IBUC's with a rated power level of 12 watts and below the power for the IBUC may be through the L-band IFL supplied from the satellite modem. The IBUC can also be supplied directly through the external power connector (J3). Options are available for 24VDC and 48VDC. Refer to the label on the unit to determine which voltage is required.

For IBUC's with a rated power of 16 watts or greater, an external power supply is required. Terrasat offers a 400W outdoor PSUI (good for all power levels up to 40W C-band or 25W Ku-band) and a 700W outdoor PSUI (good for all power levels up to 80W C-band and 40W Ku-band). Power supplies have an auto-ranging AC front end that will work with both 115VAC and 230VAC. The outdoor PSUI is shipped with a DC power cable (10ft) and mating connectors for the AC mains power cable.

Transmit In J1: The TX IN connector is a Type N, female (Type F, female optional) connector used to connect the IF at L-band from the modem to the IBUC. 50Ω cables (75Ω for Type-F connectors) should be used to connect to J1. Certain considerations must be taken when selecting the IFL since appropriate shielding and signal levels are required for normal system operation. The IBUC is designed to operate at rated power with a -30 dBm TX L-band input signal, with the variable attenuator set to minimum attenuation. The variable attenuator is accessible through the M&C for system gain adjustment. In addition the IBUC must have a 10MHz input signal between +3 to -12 dBm.

Once DC power and 10 MHz input signals are applied, the IBUC will function without the necessity of an M&C interface.

For lower power units (12W and below) the cable should also be selected for its current carrying capabilities. The low power IBUC can draw up to 4.5 amps at 37 VDC or 6

amps at 20 VDC and the LNB can draw up to 400mA at 15VDC. The maximum voltage drop for a 24VDC IBUC is 4 volts and for a 48VDC IBUC is 11 volts.

The cable should also have good shielding effectiveness in order to prevent outside interference.

Fire codes may require that cables in occupied buildings be installed in steel conduit. Local government agencies may waive this requirement with the use of Plenum cables, which are standard cables encased in solid Teflon. Check codes in your area.

NOTE: Equipment outage due to faulty installation is not covered by your warranty. Terrasat recommends the use of OEM procedures for making cables and connectors.

M&C Interface J2: The M&C Interface is a 19-pin, circular, female connector used to allow remote monitoring and control of IBUC operating parameters. Pin assignments are shown below. If the M&C port of the IBUC is going to be used the cable should be a shielded multi-conductor cable with at least two each 100 ohms twisted pairs (for TCP/IP). Please also see the IP cable drawing attached. An assembled IP test cable is available from Terrasat.

Table 4.2: IBUC M&C Connector J2, Pin Assignments

IBUC J2	
PIN	FUNCTION
A	RS485 (+)
B	RS485 (-)
C	HANDHELD TERMINAL POWER (+)
D	RS232 RXD
E	RS232 TXD
F	HHT, RS232, RS485 Common
G	TCP/IP TX +
H	TCP/IP TX -
J	TCP/IP RX +
K	TCP/IP RX -
L	IBUC ALARM OUTPUT Normally Open
M	IBUC ALARM OUTPUT Common
N	IBUC ALARM INPUT
P	IBUC ALARM OUTPUT Normally Closed
R	1+1 SWITCH COMMAND A
S	1+1 SWITCH COMMAND B
T	1+1 SWITCH INDICATOR A
U	1+1 SWITCH INDICATOR B
V	1+1 Redundancy Enable

Note that pin F is the return to close the circuit for RS232

DC Power J3: Prime power is supplied to the IBUC through a 6-pin circular female connector.

Table 4.3: IBUC Power Connector J3, Pin Assignments

IBUC J3	
PIN	FUNCTION
A	VDC -
B	VDC -
C	VDC -
D	VDC +
E	VDC +
F	VDC +

Note:

The IBUC is factory-configured for Positive Supply (+48VDC, standard) or Negative Supply (-48VDC, optional). J3 is internally connected, as follows:

Positive Supply: VDC- is connected to Common.

Negative Supply: VDC+ is connected to Common.

RF OUT: The RF out connection is waveguide (WR-75) for Ku-band units and either waveguide (WR-137) or N-type connector for C-band units.

PSUI



Figure 4-2 PSUI Front Panel

Table 4.4: PSUI Connector Schedule

PSUI CONNECTOR SCHEDULE			
REF DESIG	FUNCTION	CONNECTOR	CONNECTOR MATE
J1	AC IN	POWER CONNECTOR, MALE RCPT, 3+PE (AMPHENOL T3110-000)	POWER CONNECTOR,FEMALE, 3+PE (AMPHENOL T3109-001)
J2	DC OUT	MS CIRCULAR CONNECTOR BOX MOUNT RCPT, 6S (CAN MS3102R 14S-6S)	MS CIRCULAR CONNECTOR STRAIGHT PLUG, 6P (CAN MS3106F 14S-6P)
FAN CONN	DC TO FAN	MICRO CONNECTOR, PANEL MOUNT, 2-PIN (CONXALL 17282-2PG-300)	MICRO CONNECTOR, CABLE END, SOCKET (CONXALL 16282-2SG-311)

Power Supply Connections

AC IN (J1): Prime power, AC, is provided via the circular, 3 –pin plus ground connector. The connector is configured as follows

Table 4.5: PSUI AC Power Connector J1, Pin Assignments

PSUI J1	
PIN	FUNCTION
1	N/C
2	NEUTRAL
3	LINE
GRND	GROUND

DC OUT (J2): DC out connector is used to provide power from the PSUI to the IBUC using a 6-pin circular connector. Pin out for this connector is as follows:

Table 4.6: PSUI DC Output Connector J2, Pin Assignments

PSUI J2	
PIN	FUNCTION
A	VDC -
B	VDC-
C	VDC-
D	VDC+
E	VDC+
F	VDC+

The fan connection is a two-pin connector with a dust cover attached used to supply power to a cooling fan when installed. Units without a fan or from which the fan is removed should have the dust cover placed over the connector.

Table 4-7 PSUI Fan Connection Pin Assignments

PSUI FAN CONN	
PIN	FUNCTION
1	RETURN
2	+12VDC

Fire codes may require that cables in occupied buildings be installed in steel conduit. Local government agencies may waive this requirement with the use of Plenum cables, which are standard cables encased in solid Teflon. Check codes in your area.

NOTE: *Equipment outage due to faulty installation is not covered by your warranty. Terrasat recommends the use of OEM procedures for making cables and connectors.*

IFU



Figure 4-3 IFU Back Panel

Table 4-8: IFU Connector Schedule

IFU CONNECTOR SCHEDULE			
REF DESIG	FUNCTION	CONNECTOR	CONNECTOR MATE
J1	TX IN	TYPE-N(f), SMA(f) or F(f) (optional)	TYPE-N(m), SMA(m) or F(m)
J2	TX OUT	TYPE-N(f), SMA(f) or F(f) (optional)	TYPE-N(m), SMA(m) or F(m)
J3	EXT REF IN	TYPE-SMA(f) or BNC(f) (optional)	TYPE-SMA(m) or BNC(m)
J4	RX IN	TYPE-N(f), SMA(f) or F(f) (optional)	TYPE-N(m), SMA(m) or F(m)
J5	RX OUT	TYPE-N(f), SMA(f) or F(f) (optional)	TYPE-N(m), SMA(m) or F(m)
P1	AC POWER IN	IEC LINE CONN. PLUG	AC CORD RECPT

TX IN (J1): The TX IN connector is a Type N, SMA or F female connector used to connect the IF at L-band from the modem to the IFU. 50Ω (N or SMA) or 75Ω (F) cables

should be used to connect to J1. J1 can also carry the DC Supply for the IBUC, 10 MHz reference and FSK signal from the Modem.

TX OUT (J2): The TX OUT connector is a Type N, SMA or F female connector used to connect the IF at L-band from the IFU to IBUC. 50Ω (N or SMA) or 75Ω (F) cables should be used to connect to J2. J2 can carry the DC Supply for the IBUC (Internal or from the Modem), 10 MHz reference (Internal, External or from the Modem), and FSK signal (pass for the Modem FSK).

EXT REF IN (J3): The EXT REF IN connector is a Type SMA or BNC female connector used to connect the 10 MHz from an external source to the IFU. 50Ω (SMA or BNC) or 75Ω (BNC) cables should be used to connect to J3.

RX IN (J4): The RX IN connector is a Type N, SMA or F female connector used to connect the IF at L-band from the LNB to the IFU. 50Ω (N or SMA) or 75Ω (F) cables should be used to connect to J4. J4 can also carry the DC Supply for the LNB (Internal or from the Modem) and the 10 MHz reference (Internal, External or from the Modem).

RX OUT (J5): The RX OUT connector is a Type N, SMA or F female connector used to connect the IF at L-band from the IFU to the Modem. 50Ω (N or SMA) or 75Ω (F) cables should be used to connect to J5. J5 can carry the DC Supply for the LNB and the 10 MHz reference from the modem.

Cable and Waveguide Connections

WARNING: Ensure that all power is disconnected prior to making the following connections

When installing the cable and waveguide assemblies ensure that all connections are weather-tight. If the optional RX reject filter has been ordered attach it to the IBUC waveguide output. Ensure that proper gasketing is used to prevent water damage.

Waveguide connection:

Connect a section of flexible waveguide between the OMT transmit port and the IBUC TX RF Output (or optional RX reject filter). The waveguide should be attached to the antenna feed per the manufacturer's instructions. Ensure that proper gasketing is used to prevent water damage. Note that the C-band IBUC is also available with an optional N-type output connector that will require an appropriate RF cable between the IBUC output and the OMT instead of waveguide.

Configuration without IFU:

Connect the IFL coaxial cable between the IBUC J1 (TX L-band) and the Modem.

Connect the coaxial cable between the LNB (RX L-band) and the Modem L-band RX INPUT.

Connect the M&C cable between the IBUC J2 (M&C) and the appropriate M&C computer or LAN connection.

Connect the DC cable between the outdoor PSUI J2 (DC Output), as appropriate, and the IBUC J3 (DC Input).

Connect the AC cable between the PSUI J1 (AC Input) and the AC power source.

Configuration with IFU:

Connect the IFL coaxial cable between the IBUC J1 (TX L-band) and the IFU J2 (TX OUT). Connect a coaxial cable between the IFU J1 (TX IN) and the Modem (TX L-band OUT).

Connect the coaxial cable between the LNB (RX L-band) and the IFU J4 (RX IN). Connect a coaxial cable between the IFU J5 (RX OUT) and the Modem L-band RX INPUT.

Other connections:

Connect the M&C cable between the IBUC J2 (M&C) and the appropriate M&C computer or LAN connection.

Connect the DC cable between the outdoor PSUI J2 (DC Output), as appropriate, and the IBUC J3 (DC Input). Low power units can be supplied from the Modem or the IFU through the coaxial cable to the IBUC.

Connect the AC cable between the PSUI J1 (AC Input) and the AC power source.

Water Resistant Wrap

The application of moisture resistant wrap (mastic tape) to all outdoor connectors is recommended to prevent water entry and resultant water damage. Apply the mastic tape as follows:

- Ensure that all connectors are tight.
- Pre-cut the mastic tape to the desired size.
- Center the tape on the connector to be sealed and wrap the tape tightly around the connector. Squeeze the tape tightly and ensure that both ends of the tape have formed around the connector and the cable.
- Apply the tape to all connectors that may be exposed to moisture.

Grounding

Antenna Recommendations

Most antenna masts are encapsulated in concrete. Typically, the mast pipe is submerged in a 4 (1.22m) to 5 foot (1.53m) deep augured hole. This provides a good Ufer ground. An Ufer ground, in this case, is defined such that concrete retains

moisture for 15 to 30 days after rain or snow melt. Concrete absorbs moisture quickly, yet retains moisture for a period of time. The concrete's large volume and great area of contact with the surrounding soil allows a good transfer to the ground.

In the concrete base, an Ufer ground can be established by running a #4 gauge solid wire or rebar and connecting with pigtails to the base of the pedestal.

The Ufer ground is only one step in proper grounding. The Ufer ground should be augmented with coupled pairs of 10 foot (3.05m) rods, placed 20 feet (6.1m) into the ground, spaced 20 feet (6.1m) apart. The first rod should be placed close to the antenna. The second rod should be placed towards the equipment enclosure. A #2 gauge wire should connect the rods and antenna mount. A ground rod should be placed at the equipment enclosure as well. If it is virtually impossible to install the ground rods, then radials are needed. This can be accomplished by laying 10 or more lengths of 1 1/2-inch (3.81cm) copper strap, at least 50-feet (15.24m) long, in a radial fashion around the antenna base. The straps should be buried, if possible. The hub must be interconnected to the utility ground.

The ground configuration can vary from one location to another. It is best to measure the soil conductivity and design a 5 ohm ground system. To protect the system from a direct strike, a lightning rod placed 2 feet (61 cm) higher than the highest point of the dish should be interconnected to the Ufer ground with #2 gauge copper wire.

IBUC / PSUI Grounding Recommendations

Grounding and lightning protection is recommended as follows.

Cable Shielding: The shield currents can be eliminated with proper techniques. A grounding strap at the end of the coaxial and data cables should be connected to the ground lug at the antenna base with a #4 gauge copper wire. This provides a path of least resistance prior to entering the electronic equipment.

AC: The best way to protect the equipment is to have two protectors. The first is the power mains protector that is mounted directly across the mains in the breaker box. The second should be mounted or grounded directly at the base or hub of the antenna or at the 19 inch rack.

Data and Control Lines: The I/O lines can deliver surge current to the equipment and should be protected as well.

Electrical grounding: Grounding of the IBUC and PSU units is recommended to prevent possible damage from lightning and/or other induced electrical surges. It is recommended that 3/0 or 4/0 AWG (American Wire Gauge) stranded copper wire be used to bond the IBUC and the PSU to the earth ground (grounding rod), using the most direct (shortest) route.

SYSTEM ALIGNMENT and OPERATION

General

The sections below outline the procedure for setup and alignment of the earth station. Prior to the ODU alignment, the antenna should be set to the desired azimuth and elevation settings per manufacturer's instructions.

CAUTION: THE IBUC MUST NOT TRANSMIT UNTIL ALIGNMENT AND ANY NECESSARY ADJUSTMENTS ARE COMPLETE.

Test Equipment

The following equipment or equivalent is recommended for installation and system alignment:

Table 4-9 Recommended Test Equipment

Equipment	Type
Spectrum Analyzer	HP8563E
Digital Voltmeter	Fluke 8050
Adapter Waveguide to coax	C or Ku-band
RF cables	With calibrated insertion loss up to 15GHz
40 dB attenuator	High Power to match HPA output.
Assortment of cables, connectors and adapters (calibrated up to 15 GHz)	

Ensure that the IBUC TX output power is disabled to prevent accidental transmission interference with adjacent satellites or transponders before attempting to align or performing any other operation involving the ODU. Before attempting any system change, carefully evaluate the possible effects of the transmitted signal.

Setting the TX and RX Frequencies

All transmit and receive frequencies are set in the modem.

For a direct connection to an L-band modem follow the manufacturer's instructions on setting the transmit and receive frequencies.

Receive L-band Output Measurements

To check the Receiver, perform the following:

- Ensure that 15-24VDC (LNB Bias) is present at the modem or IFU RX input.
- Use a spectrum analyzer to ensure that the 10MHz signal is present at the modem or IFU RX input.

Warning; DC power will be present on the cable so the use of a DC block is recommended.

- Connect the LNB to the demodulator RX input by attaching the coaxial cables from the RX L-band OUT on the LNB to the demodulator RX L-band input port. When configured with the IFU, connect the IFU RX OUT (J5) to the demodulator RX L-band input port and connect the LNB to the IFU RX input by attaching the coaxial cables from the RX L-band OUT on the LNB to the RX input port (J4) on the IFU.

Antenna Alignment

WARNING: WHEN ALIGNING THE ANTENNA, THE IBUC MUST NOT TRANSMIT.

Ensure that the desired transponder is in operation. To find the satellite and peak the receive signal, perform the following:

- Apply power to the LNB.
- Sweep the antenna through previously determined azimuth and elevation adjustments. Note: This must be done very slowly in order to locate the satellite.
- Simultaneously, monitor the RECEIVE signal level at the demodulator. Wideband signals such as video carriers are easiest to find and should be used when available.
- Tune the antenna and adjust its polarization according to the antenna manufacturer's instructions until the satellite is found.

TX Power Alignment

Transmit L-band Input Adjustment with Modem or Converter

Warning; DC power may be present on the cable so the use of a DC block is recommended when performing the following steps.

To set the power level of the modulator output:

- With a spectrum analyzer, measure the power level of the L-band signal at the output of the coaxial cable that connects to the IBUC at J1 (TX L-band).
- Use the modem or converter level adjust to increase and decrease the power level. Adjust this for a level of -30 dBm (this will result in rated power at the IBUC output). For shorter cable runs the attenuator in the IBUC may be used.
- Check that the 10MHz reference signal is between +3 and -12 dBm.
- Disconnect the spectrum analyzer from the coaxial cable.

Transmit RF Output Adjustment with Modem or Converter (70 MHz to L-band)

To adjust the power level of the IBUC transmitter output:

- Connect a waveguide to coax adapter and a 40dB high power attenuator to IBUC TX waveguide output.
- Connect the TX L-band input signal to J1 (TX L-band) on the IBUC.
- Enable the TX signals in the modem or converter and the IBUC.
- Measure the RF output with the power meter connected at the waveguide output. For accuracy measure pure carrier.
- With a Satellite modem: Adjust the RF output to the designated power level (provided by the satellite network operation center, or its engineering staff) with the L-band output (modem) level adjust.
- Disable the TX signal in the modem or converter.

- Disconnect the TX L-band input signal.
- Remove the waveguide to coax transition and install the transmit waveguide section to the antenna transit feed.
- Once the transmit input and output power levels have been set, begin transmitting by connecting the TX L-band input signal to J1 on the IBUC and enabling the TX in the modem or converter.
- Under the guidance of the Network Operations Center (NOC), fine adjust the transmit power for the desired down link margin at the receiving station by adjusting the TX L-band output level adjust (modem or converter output).

Final Checks

To ensure optimum operation, inspect the system for crimped or pinched cabling. Make sure all connections are secure and sealed. Once the system has been aligned and is operating satisfactorily, the IBUC will require a few infrequent and simple maintenance procedures as described in Maintenance and Service, chapter 5.

M&C Setup

Note: RS485/FSK Mode 1 is the default setting to enable compatible modems to use the "Legacy binary" mode to communicate with the IBUC.

General

Communication with the IBUC can be accomplished via any of five interfaces: TCP/IP, RS232, RS485, Handheld Terminal (HHT), and FSK Link. The first four use the M&C connection (J2) with an appropriately configured cable and terminal. FSK Link uses FSK signals between the IBUC and modem that are multiplexed on the IFL coax cable.

TCP/IP:

Communication with the IBUC via TCP/IP can be through Telnet (ASCII) or the onboard web server (HTTP). The IBUC uses a static IP addressing structure and does not support DHCP. The IBUC is factory-configured as follows:

IP Address 192.168.1.21

IP Gateway 192.168.1.1

Subnet Mask 255.255.255.0

Telnet Port 23

Note: Your computer should have a static IP address on the same subnet as the IBUC. Using a suitable cable, connect the computer to the IBUC J2 connector. Note: If an Ethernet hub is not used to connect to the IBUC, then a crossover cable must be used. An Ethernet hub will function with a straight connect cable.

Telnet:

On the host computer activate a command prompt window. Enter Telnet 192.168.1.21 and a cursor should appear on the left of the screen. Type the password command, CPE=1234, and the response will be IBUC>_. Commands may now be entered to access the IBUC functionality. (See the entire command list in Chapter 6).

Web Server:

On the host computer activate a web browser window. In the address window type [HTTP://192.168.1.21](http://192.168.1.21) and press enter. Within a few seconds you should see the login screen. On the login screen, enter 1234 in the login box and press the Login button. You will be taken to the Alarm Status page where you can select from the following web pages:

- Alarm Status
- Transmit Status
- Transmit Config
- Interface Config
- System Config
- Alarm Config

The “Status” pages enable monitoring of various IBUC parameters. Alarms are color coded with green indicating OK, orange as a warning, and red as an alarm condition.

The “Configuration” pages provide access for changing factory default settings to suit specific site or network requirements. Settings take effect when you press the “Update” button. Note that some changes in configuration will cause a loss of communication with the host computer. It will then be necessary to make the corresponding change in the host computer. For an example, here are instructions on changing a unit’s IP address (using the default settings):

Navigate to the “Interface Config” page

Change the IP address to something other than 192.168.1.21 (the factory default)

Press “Update”.

Note that IP address changes will not take effect in the IBUC until it is reset. Using the Webpage to change address will reset the unit automatically. In the host computer web browser type the new address and come back in through the Login page.

RS232:

No configuration of the IBUC is required for proper RS232 operation. The RS232 port uses ASCII protocol and a fixed baud rate of 9600 for communication. On the host computer set the serial port settings to the following: Baud rate to 9600, data bits to 8, parity to none, stop bits to 1, and flow control to none. The IBUC can be accessed using a terminal program on the host computer such as HyperTerminal. Hit enter several times and you should see the “IBUC>” prompt. Type CPE=1234 and the IBUC> prompt should return. The IBUC is now ready to accept commands.

Following are two examples, which use the default settings. If you need to reconfigure these settings, this describes the sequence of events:

To configure TCP/IP do the following:

```
CIA=192.168.1.21 // IP Address
CIG=192.168.1.1 // IP Gateway
CIM=24 // Subnet Mask
CIP=23 // Telnet Port
```

To configure RS485 do the following:

```
C4A=1 // RS485 Address
C4D=20 // RS485 Delay
C4R=9600 // RS485 Baud rate
If ASCII mode is desired type
C4M=0 // RS485 Mode (Not factory
default)
If Legacy mode is desired type
C4M=1 // RS485 Mode
```

RS485:

The RS485 interface is intended primarily as an NMS interface accessed by a Network Management Software program. It is possible to access the RS485 interface with a host computer using an onboard RS485 card.

Communicating with the IBUC across RS485 can be through ASCII or a proprietary binary protocol referred to as Legacy.

ASCII mode:

The default configuration is Legacy Binary mode so it will be necessary to reconfigure the IBUC in order to use ASCII mode. ASCII mode can be selected via the web page in TCP/IP or using the HHT or RS232 to configure the 485 address (1), 485 line delay (20), 485 mode (0) and 485 baud rate (9600).

Communication through a terminal program such as HyperTerminal requires an onboard RS485 card in the host computer. In HyperTerminal type the password command: <0001/CPE=1234 followed by the enter key. Once the < prompt comes back the IBUC is ready to accept commands. In the above example <0001/ is the address of the IBUC followed by the desired command.

If an external box is used to convert RS232 to RS485, then a terminal program will not function. These boxes are designed to work with the RTS/CTS lines manually which a terminal program cannot handle. In these cases, a network management program is required to handle this handshaking requirement.

Legacy (binary) mode:

This is the default setting of the IBUC. In this mode the BUCMON program supplied on the CD accompanying the unit is the simplest method to communicate with the IBUC. Otherwise, a network management program must be provided.

HANDHELD TERMINAL (HHT):

No IBUC configuration is required to use the HHT. To activate the HHT, connect the supplied cable to the IBUC connector labeled J2 and plug the phone jack into the HHT. Once a flashing cursor is seen in the upper left part of the screen, press the decimal key on the HHT 4 times to activate the HHT. The login screen will appear. Enter the default password of 1234.

The Handheld Terminal Menu Tree is in the Operation Manual, Chapter 6, Figure 6.2.

FSK LINK:

Several brands of Modem have the capability to communicate with a Block Up Converter (BUC) using an FSK signal multiplexed onto the IF output connector along with the Tx IF signal and 10 MHz reference. This enables the operator to monitor and control the IBUC from the modem front panel. The IBUC default configuration is RS485/FSK Mode 1 (Legacy Binary mode) since all modems currently require this protocol for FSK links. The IBUC is also capable of FSK communication using ASCII mode but requires a modem compatible with this method. Refer to the modem manual for commands and procedures for FSK communication with the IBUC.

A Multi-function LED is mounted on the IBUC housing to provide visual indications of IBUC status. LED colors and modes are as follows:

- Flashing Green - No Alarms
- Flashing Red - Minor Alarm being reported
- Steady Red - Major Alarm being reported

Major and Minor alarms are defined in the Chapter 6 of this manual. Note that certain alarms are configurable giving the user the ability to define them as Major or Minor alarms.

Chapter 5 IBUC Systems: Service and Maintenance

This chapter contains the information that pertains to servicing and maintaining the Terrasat ODU's.

Service and Maintenance

General

The Terrasat PSUI's and ODU's are self-contained units that require very little maintenance.

Standard Maintenance

For optimum performance, inspect the mechanics of the system every six months. Clean the antenna feeds as necessary to keep them clear of obstructions and check the cables and connectors for signs of wear, damage or loose connections. Check all fan intakes and exhausts to ensure that they are free and clear of debris.

FAULT ISOLATION

Transceiver Fault Isolation

The information contained in this section should suffice in determining whether a Terrasat PSUI or ODU is faulty. The intent is to determine a "GO" or "NO GO" situation based on alarms indicated through the M&C ports, as well as measuring certain signals using test equipment.

AC Power Problems / Conditioning

In today's electrical environment there are many types of power related problems that prevent proper operation of sensitive electronic equipment. These noise problems or disturbances can be caused by such things as voltage induced by lightning, the switching On/Off of high power electrical equipment, or utility company actions such as power factor correction. Serious problems can arise with the occurrence of transients and spikes causing random errors, or even failure of the PSUI circuitry. Whatever the origin of the transients, they can be classified in two simple categories:

COMMON MODE: This is the noise voltage that appears equally and in phase from each signal conductor to ground.

NORMAL MODE: This is the noise potential between the power line conductors. It adds to and subtracts from the power line sinusoidal voltage wave.

Category A

At the wall outlets (and more than 30 feet from a distribution panel) the typical noise is a 0.5 microsecond rise time up to 6 kV peak, open circuit voltage 100 kHz ring wave with 200-ampere short circuit current capability.

Category B

At the distribution panel one can experience the 100 kHz ringwave above but with 500 ampere current capability and a unidirectional impulse up to 6 kV potential rising in 1.2 microseconds and decaying to half voltage in 50 microseconds. Accompanying this can be a short circuit current up to 3000 amperes rising to peak in 8 microseconds and decaying to half value in 20 microseconds.

To ensure uninterrupted service a line conditioner and/or UPS is recommended based on the expected AC power at the site.

Site Related Problems

VSAT antennas are often fitted on top of buildings. Avoid close proximity to elevator motors, etc. Also ensure that the satellite signal path is free and clear of obstructions.

M&C Checks

When troubleshooting the IBUC the first level of troubleshooting should be to check the status through the M&C ports. Alarms and an alarm history are available in the IBUC M&C. Refer to chapter 6 for specific information when using the RS232, RS485, Ethernet or Handheld Terminal ports.

Power Supply Checks

Before starting the RF troubleshooting first verify that the proper voltages are being supplied to the IBUC. Input DC Voltage and IBUC current consumption data are available from the IBUC M&C. Verify that values are within limits. If M&C is not available, use a multimeter to verify that the appropriate voltages (24VDC or 48 VDC) are present at the IBUC. The labeling on the IBUC has the required voltage (24VDC or 48VDC). The IBUC DC supply may be through J1 or J3.

Transmit Power Setting

There have been several cases where the transmit power has been turned up to or near saturation while transmitting a digital carrier. This most likely will result in spectral distortion, i.e., "shoulders", "ears", etc.

When transmitting digital carriers, it is customary to operate the power amplifier system with an Output Back Off (OBO) sufficient to meet the spectral density mask requirements.

TX IF Input Level Verification

If low or no TX output power is detected, start the troubleshooting by checking the input to the IBUC. Use the following procedures:

Warning; DC power may be present on the cable so the use of a DC block is recommended when performing the following steps.

- Check the TX Input Level displayed in M&C or disconnect the cable at the IBUC J1 (TX L-band) and use a spectrum analyzer to measure the power level of the L-band signal at the output of the coaxial cable that connects to the IBUC at J1 (TX L-band). The L-band signal level should be between -20 and -55 dBm. If it is not, check the cable and modem output.
- If the L-band signal is good, check that the 10MHz-reference signal is between $+3$ and -12 dBm and is distortion free. If it is not, check the cable and modem output (or IFU TX OUT).
- If the L-band and 10MHz signals are good check that the DC voltage level is within range. For 12 watt and lower power units only the DC voltage may be on the L-band IFL or from a separate power supply. For higher power units the DC voltage will be on the DC cable that is connected to the IBUC J3 (DC Input). If it is not, check the PSUI or modem (or IFU) power supply outputs and cables. The PSUI has a visual indication when it's turned on (green LED).
- If the L-band, 10MHz and DC voltage signals are good proceed to the IBUC TX Output verification.
- Disconnect the spectrum analyzer from the coaxial cable.

IBUC TX Output Verification

This check assumes that the L-band, 10MHz and DC inputs are at the correct levels.

- TX Output level is monitored and displayed in the IBUC M&C.
- Alternatively, you may connect a waveguide to coax adapter and a 40dB high power attenuator to the IBUC TX waveguide output.
- Measure the TX RF output with the spectrum analyzer connected at the waveguide output. Ensure that the cable loss of the cable being used for the measurement has been taken into account.
- The RF power should be between rated power and rated power -25 dB. If it is not, the IBUC is defective and should be returned to the factory for repair.
- If the IBUC TX RF output measures good, check the waveguide, feedhorn and antenna for proper operation.

Receive L-band Output Verification

If low or no RX output power is detected, start the troubleshooting by checking the output of the LNB. Use the following procedures:

- Ensure that the 15-24VDC (LNB Bias) is present at the modem RX input (or IFU RX IN) using a DVM. If it is not, check the cable and modem.
- Use a spectrum analyzer to ensure that the 10MHz signal is present at the modem RX input (or IFU RX IN). If it is not, check the cable and modem.

Warning; DC power will be present on the cable so the use of a DC block is recommended.

- Connect the LNB to the demodulator (or IFU) by attaching the coaxial cables from the RX L-band OUT on the LNB to the demodulator (or IFU) RX L-band input port. If the RX level is low check the cable, the feedhorn and antenna for proper operation.

Common Problems

The following common problems or occurrences have been noted during normal troubleshooting:

Supply voltage at IBUC is low or missing

10MHz reference at the IBUC is at the wrong level or missing

10MHz phase noise does not meet the minimum requirements

Antenna is misaligned

Bad OMT and/or antenna

Damaged cables

Antenna on the wrong satellite

TX L-band input level is misadjusted or turned off

Water in the IBUC due to no gasket in the waveguide or a hole in the feed window.

Water in the coax connectors

Incorrect frequency settings

Tx output is disabled

Repair Policy

The Terrasat IBUC and PSUI are not field repairable.

In the event that a failure has been detected it may be necessary to return the defective unit to the factory or factory authorized service center. Refer to chapter 1 for returning a defective unit to the factory.

Chapter 6 IBUC Systems: M&C Functions

Description of Operation

For remote operation the IBUC is equipped with a Monitor and Control function. The IBUC I/O includes an FSK modem interface, an RS-232 interface, an RS-485 interface, a handheld terminal, an Ethernet interface, one Multi-function LED, and one alarm relay closure (Form-C).

USER INTERFACES

- 1) **The multi-function LED** is mounted on the IBUC housing to provide visual indications of IBUC status. LED colors and modes are as follows:

Flashing Green - No Alarms
Flashing Red - Minor Alarm being reported
Steady Red - Major Alarm being reported

Major and Minor alarms are defined in the following table. Note that certain alarms are configurable giving the user the ability to define them as Major or Minor alarms. Major alarms are the ones that will cause Relay closure (Form-C). The table below shows the default configuration.

There is a command that allows the user to disable the multi-function LED (See the Handheld Menu Tree, figure 6.2 and / or the Command List, table 6.9).

Table 6-1 LED Alarms

		Alarm State		
		Major	Minor	None
TX Alarms	User Configurable	Solid RED	Flashing Red	Log Only
DRO out of lock	No	X		
TX Output Level High	Yes	X		
TX Output Level Low	Yes	X		
TX Input Level High	Yes		X	
TX Input Level Low	Yes		X	
Temperature Alarm	Yes		X	
TX Simulated Fault	No	X		
10MHz Reference Fault	No		X	
Input Voltage Out of Range	No		X	
Switch Fault	No	X		
Input Current Out of Range	No			X
AGC/ALC Target Out of Range	No			X
AGC/ALC out of range	No			X
AGC/ALC not settled	No			X

2) **The Hand Held Terminal (HHT)** is an optional item that may be used to access the IBUC for local M&C via the M&C port J2. The HHT has a 4 row x 20 column display with 4 function keys (F1-F4), a numeric keypad (0-9), and YES, No, BKSP (backspace), SPACE, & ENTER keys. Initiate HHT operation by entering “....” (4 dots), followed by the password. The default password is “1234”.

Refer to figure 6-1 for the HHT layout.

The HHT menu consists of a main menu with multiple sub-menus. The sub-menus may be selected by entering the corresponding digit as displayed on the HHT display. To maneuver back to the previous screen simply hit the BKSP (backspace) key. Some screens (i.e. INFO) only display information whereas other screens require user inputs. User input fields are reflected by the corresponding digit and a colon (i.e. 0:) as shown in the HHT Menu Tree (figure 6-2).

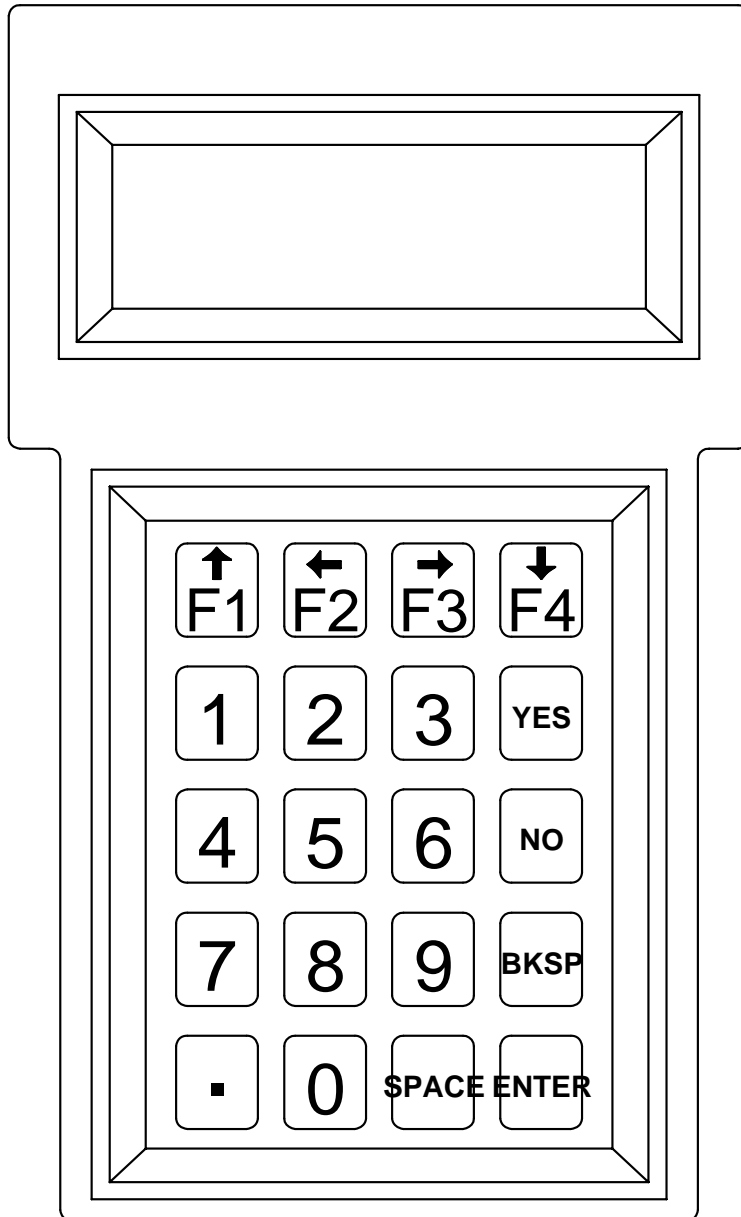

Figure 6-1 IBUC Hand Held Terminal

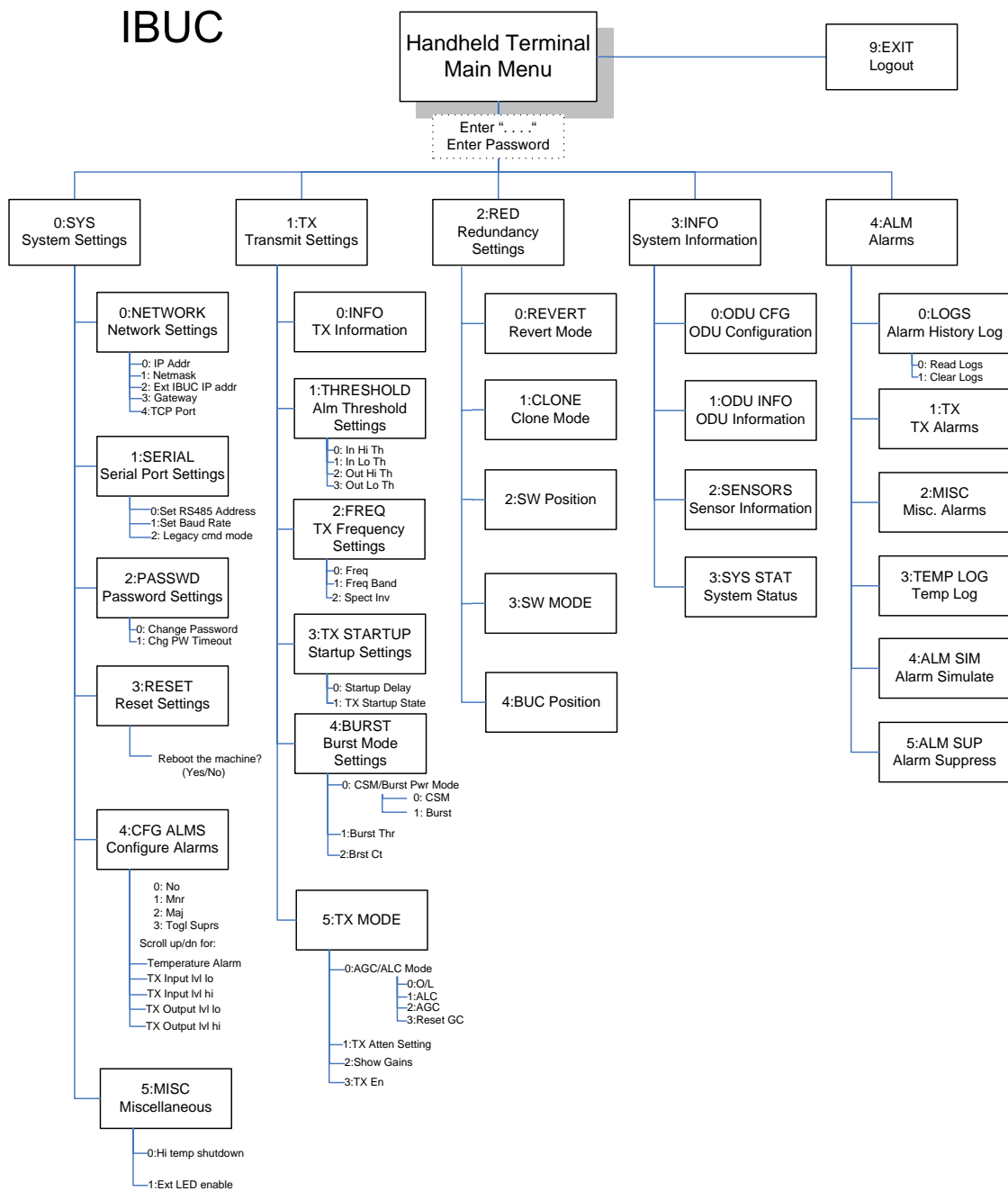

Figure 6.2 Hand Held Terminal Menu Tree

3) **The FSK** multiplexed onto the IF cable by means of an FSK modulated signal. FSK operation allows two modes: Legacy-binary and ASCII. FSK-capable modems may require that the IBUC operate in the legacy mode. Commands and values available

in ASCII mode are shown in the command set, Table 6.9. Commands and values available in Legacy mode are shown in item 4) RS-485, pages 6-6 through 6-10. FSK and RS-485 are tied together by the Mode of operation (Legacy-binary or ASCII). Once the mode is selected, both will work in the same mode. FSK link specifications are as follows:

Transmitter

Frequency	650 KHz +/-5%
FSK deviation	+/- 60 KHz Nominal (+60 KHz mark)
Deviation tolerance	+/- 50 KHz minimum ; +/-70 KHz maximum
Output Level	-5 to -15 dBm
Output impedance	50 OHM
Start Tone	710 KHz
Start Tone time	10 ms

Receiver

Locking range	+/- 32.5 KHz
Input impedance	50 OHM
Input Sensitivity	-15 dBm

For FSK operating in Legacy Binary the data will be transmitted at 9600 bit/s with 8 data bits, no parity, and one stop bit.

In order to maintain synchronization, the RS485 receiver will reset if a message is not completed within 50 ms of initiation.

The IBUC is capable of responding to messages at rate of one every 20 ms.

4) **RS485** two wire half-duplex which is on a separate cable. There are two modes of operation for RS-485 interface: ASCII mode and Legacy-binary mode.

RS-485 in ASCII mode:

The RS-485 interface is a standard 2-wire interface (DATA+, DATA-). The baud rate is programmable to 1200, 2400, 4800, 9600, 19200, 38400, 57600 or 115200 Baud. The data is transmitted asynchronously as 8 bits, no parity, and 1 stop bit.

Basic protocol:

- Start of Packet: < (ASCII code 60; 1 character)
- Target Address: (4 characters)
- Address De-limiter: / (ASCII code 47; 1 character)
- Instruction code: (3 characters)
- Code qualifier: = or ? (ASCII code 61 or 63; 1 character)
- Optional arguments: (n characters)
- End of Packet: Carriage Return (ASCII code 13; 1 character)

Example: <0001/CPE=1234{CR}

Commands and values available in ASCII mode are shown in the command set, Table 6.9.

RS-485 in Legacy binary mode:

For RS-485 interfaces operating in Legacy-binary mode, the data will be transmitted at 9600 bit/s with 8 data bits, no parity, and one stop bit. In order to maintain synchronization, the RS485 receiver will reset if a message is not completed within 50 ms of initiation.

The BUC is capable of responding to messages at rate of one every 20 ms.

For the RS-485 interface, the packet is encapsulated inside of a data link layer packet which has an address “header” byte and a checksum “trailer” byte. The packet format is as follows:

Byte	Description
1	RS-485 Destination address of command. For responses, responder address is shifted left by 4 bits.
2 through N	Command or Response Packet with CR/LF termination.
N+1	CHECKSUM; The sum of Bytes 1-N+1 should equal zero.

Each transmitted data packet consists of 7 bytes as shown in table 7-1.

Table 6-2 BUC Data Packet Byte Configuration

Byte 1	Byte 2	Byte 3	Byte 4	Byte 5	Byte 6	Byte 7
BUC Address	Command	Data Byte 1	Data Byte 2	Factory Use	Not Used	Check Sum

The 1st byte contains the BUC address that is being queried. The BUC will only accept a command if the 1st byte contains the appropriate address.

The 2nd byte contains the major command. See table 6-3 for possible commands.

The 3rd and 4th bytes contain the specific command values. See table 6-3 for possible commands.

The 5th byte is used for factory settings only.

The 6th byte is not used.

The 7th byte contains the algebraic sum of bytes 1 through 6. Commands are only executed if the checksum coincides, but a status response will be sent if the address is correct and the command number is within the valid range. Spare bytes are always filled with hex AA (10101010), to balance the FSK.

The maximum response time of the BUC is 20ms. If the BUC does not respond within the maximum response time, the command should be cyclically repeated.

Command Message Structure

Refer to the Data Field Definitions at the end of this section for valid settings.

Table 6-3 Table of BUC Commands

Byte	Name	Description	Value
1	Address	BUC address	0x01 to 0x0F
2	Command	Request status	0x01
		Set Transmit on/off state	0x02
		Change BUC address or set RS485 response delay	0x03
		Set detected carrier frequency	0x04
		Set power threshold	0x05
		Request burst power level	0x06
		Request device type ID	0x07
		Request / set temperature log	0x09
3	Data Byte 1		
	If command=		
	0x01	Not used	0xAA
	0x02	TX control	0=Off 1=On 2=Off @ Pwr On 3=On @ Pwr On
	0x03	Set new BUC address	0x01 to 0x0F
	0x04	Set detected carrier frequency MSB	MSB
	0x05	Set Power threshold MSB	MSB
	0x06	Request "current burst power" selector	0x00
		Request "stored min/max burst power" selector	0x01
	0x07	Request "BUC S/N" selector	0x00
	0x09	Leave TX on at temp alarm	0x00
		Enable TX off at temp alarm	0x01
		Get Temp Log Status	0x03
4	Data Byte 2		
	If command=		
	0x01	Not used	0xAA
	0x02	Not used	0xAA
	0x03	RS485 delay value in ms	0x01..0xFF

	0x04	Detected carrier frequency LSB	LSB
	0x05	Power threshold LSB	LSB
5	Data Byte 3	Factory Use Only	0xAA
6		Not used	
7	Checksum	Algebraic Sum of bytes 1-6	Sum of bytes
1-6			

*Notes:

Command 0x05

For CSM mode the setting must be at 20.1 dB below rated power. For burst mode the setting must be between rated power and no lower than 20 dB below rated power.

Command 0x03, Data Byte 2

The smallest delay is 0x01, which is 1ms. The delay value of 0x00 is equal to 0xFF and gives a 256ms delay. The delay value of 0xAA is the only exception; it will not change anything. It is aimed to keep compatibility with previous versions of the software. It should be noted, that the time delay may not be accurate when the EEPROM write command is being executed (delay time longer by few ms).

Response Message Structure

Refer to the Data Field Definitions at the end of this chapter for valid settings.

Table 6-4 Response to BUC commands 0x01, 0x02, 0x03, 0x04, and 0x08

Byte	Name	Description	Value
1	Address	Reports BUC Address shifted left by 4 bits	0x10 to 0xF0
2	Level Byte 1	Reports current TX output power MSB	MSB
3	Level Byte 2	Reports current TX output power LSB	LSB
4	Temperature	Reports Housing Temperature in °C	
5	Status Byte 1		
	Bit 0:	Housing Temperature	1=Out of Range 0=Normal
	Bit 1:	PLDRO lock	1=Out of Lock 0=Normal
	Bit 2:	Checksum	1= Command Error 0= Normal
	Bit 3:	TX status	1=On, 0=Off
	Bits 4 to 7:	Power class	0x1 to 0xA
6	Status Byte 2		
	Bits 0 to 3:	Summary Alarm = On	0x9
		Summary Alarm = Off	0xA
	Bits 4 to 7:	Software version	0x0 to 0xF
7	Checksum	Algebraic Sum of bytes 1-6	Sum of bytes

**Table 6-5 Response to BUC commands 0x05, 0x06
(when Data Byte 1 of command message = 0x00)**

Byte	Name	Description	Value
1	Address	Address of BUC shifted left by 4 Bits	0x10 to 0xF0
2	Level Byte 1	Current TX output power (burst mode)	MSB
3	Level Byte 2	Current TX output power (burst mode)	LSB
4	Level Byte 3	Current power threshold	MSB
5	Level Byte 4	Current power threshold	LSB
6	Bits 0 to 3:	If command = 0x05	0xB
		If command = 0x06	0xC
	Bits 4 to 7:		0x00
7	Checksum	Algebraic sum of bytes 1-6	Sum of bytes

**Table 6-6 Response to command 0x06
(when Data Byte 1 of command message = 0x01)**

Byte	Name	Description	Value
1	Address	Address of BUC shifted left by 4 bits	0x10 to 0xF0
2	Level Byte 1	Max stored TX output power (Burst mode)	MSB
3	Level Byte 2	Max stored TX output power (Burst mode)	LSB
4	Level Byte 3	Min stored TX output power (Burst mode)	MSB
5	Level Byte 4	Min stored TX output power (Burst mode)	LSB
6	Bits 0 to 3		0xD
	Bits 4 to 7		0x00
7	Checksum	Algebraic sum of bytes 1-6	Sum of bytes

Table 6-7 Response to command 0x07

Byte	Name	Description	Value
1	Address	Address of BUC shifted left by 4 bits	0x10 to 0xF0
2	Bits 0 to 3	Manufacture ID	2
	Bits 4 to 7	Frequency Band ID	1 to 15
3	S/N Byte 1	Decimal digits 1 and 2 of serial number	Binary 0000 to 1001
4	S/N Byte 2	Decimal digits 3 and 4 of serial number	Binary 0000 to 1001
5	S/N Byte 3	Decimal digits 5 and 6 of serial number	Binary 0000 to 1001
6	Bits 0 to 3		0xD
	Bits 4 to 7		0x0
7	Checksum	Algebraic sum of bytes 1-6	Sum of bytes

Table 6-8 Response to command 0x09

Byte	Name	Description	Value
1	Address	Address of BUC shifted left by 4	0x10...0xF0
2	Data Byte 1	Temperature Shutdown @ Temp State	0x00=Off, 0x01=On
3	Data Byte 2	Minimum Stored Unit Temperature (two's complement if below 0)	0x00...0xFF
4	Data Byte 3	Maximum Stored Unit Temperature (Two's complement if below 0)	0x00...0xFF
5	Data Byte 4	Number of writes to temp. memory after memory was cleared or unit rebooted	0x00...0xFF
6		Not used	
7	Checksum	Algebraic sum of bytes 1-6	Sum of bytes

Data Field Definitions

1. BUC Address: Integer between 1 and 15
2. TX Power Level: Integer in 1/100 dBm
3. Detect threshold: Integer in 1/100 dBm
4. Carrier Frequency: Integer in MHz
5. Temperature: Character in °Celsius
6. Power Class:

2 Watt	1
4 Watt	2
5 Watt	3
8 Watt	4
10 Watt	5
16 Watt	6
20 Watt	7
25 Watt	8
40 Watt	9
60 Watt	10 (A)
30 Watt	11 (B)
80 Watt	12 (C)
100 Watt	13 (D)
12 Watt	14 (E)
7. Frequency Band

Standard C-band	3
Palapa C-band	12
Insat C-band	4
Standard Ku-band	6
Extended Ku-band	5
X-band	7
Full Ku-band	8
Extended C-band	9

8. Serial Number: The data word consists of 3 Bytes, 4 bits are reserved for each respective decimal digit. The S/N consists of less than 6 decimal digits, the remaining digits are filled by zeros (0). For example, S/N 129;

Byte 1		Byte 2		Byte 3	
1 0 0 1	0 1 0 0	1 0 0 0	0 0 0 0	0 0 0 0	0 0 0 0
9	2	1	0	0	0

5) **TCP/IP** via Ethernet cable:

The Ethernet port is a highly integrated Ethernet Controller which offers an NE2000 compatible adapter with full duplex and power down features. The full-duplex function enables simultaneously transmission and reception on the twisted-pair link to a full-duplex Ethernet switching hub. The Ethernet interface is connected through an isolation transformer and filter.

For the Ethernet interface, the packet is encapsulated in several layers (TCP segment inside of an IP datagram inside of an Ethernet frame). The Ethernet MAC address is preset at the factory – each IBUC having a unique MAC address. The IP address, network mask, default route, DNS server, and TCP listen port are configurable through the Hand held Terminal interface. The IBUC controller does not support DHCP.

The command set for IBUC RS232, RS485 (ASCII mode), FSK (ASCII mode), TCP/IP and Hand Held Terminal is shown in Table 6.9 (below).

Table 6-9 IBUC M&C Command Set

Parameter	<value> Valid Values (See Notes Below)	Comments	Command	Burst/ CSM Mode	Config allowed if slave?	Default Value	HHT [Note 4]	RS- 232 Port	RS- 485 Port ASCII	FSK Port ASCII	RS-485 Binary(1)	FSK Port Binary(1)	Telnet Port
-----------	---	----------	---------	-----------------------	--------------------------------	---------------	--------------------	--------------------	-----------------------------	----------------------	---------------------	-----------------------	----------------

System Configuration													
Get 10MHz detector	1=10MHz within Range, 0=10MHz out of range	Returns the state of the TEN_MHZ_DET line	C10?	all		na	X	X	X	X	No	No	X
Get RS485 Address			C4A?	all		na	X	X	X	X	No	No	X
Set RS485 Address	ASCII: 1 to 254 Legacy: 1 to 15	Configures the RS-485 Address. New address takes effect IMMEDIATELY - (i.e. before response is returned).	C4A=<value>	all		1	X	X	X	X	X	X	X
Get RS485/FSK Delay			C4D?	all		na	No	X	X	X	No	No	X
Set RS485/FSK Delay	1 to 255	Sets the RS485 and FSK Rx/Tx Turnaround delay in Msec.	C4D=<value>	all	no	20	No	X	X	X	X	X	X
Get RS485/FSK Mode			C4M?	all		na	X	X	X	X	No	No	X
Set RS485/FSK Mode	0=ASCII Packet, 1=Legacy Binary	Sets the RS485 and FSK ports to Legacy Binary mode (1) or Ascii Packet mode (0). Receipt of this command IMMEDIATELY resets the RS485 and FSK serial ports.	C4M=<value>	all	no	1	X	X	X	X	No	No	X
Get /RS485 Data Rate			C4R?	all		na	X	X	X	X	No	No	X
Set RS485 Data Rate	1200, 2400, 4800, 9600, 19200, 38400, 57600, 115200	Configures the RS-485 baud rate. Takes effect after reboot.	C4R=<value>	all	no	9600	X	X	X	X	No	No	X
Get Verbose Messages			C4V?	all		na	No	X	X	X	No	No	X
Set Verbose Messages	0 = terse, 1=verbose	Sets the response of the serial and TCP connections to terse (for computers to read) or verbose (for people to read).	C4V=<value>	all	no	0	No	X	X	X	No	No	X

Table 6-9 IBUC M&C Command Set

Parameter	<value> Valid Values (See Notes Below)	Comments	Command	Burst/ CSM Mode	Config allowed if slave?	Default Value	HHT [Note 4]	RS- 232 Port	RS- 485 Port ASCII	FSK Port ASCII	RS-485 Binary(1)	FSK Port Binary(1)	Telnet Port
Get Alarm Flags		See Table 3 for defined error flags	CAS?	all		na	X	X	X	X	X	X	X
Get Alarm Flags (Verbose)			CAS=1	all		na	X	X	X	X	No	No	X
Get Model and Serial Number	m,s where m is an ASCII string of up to 19 characters representing the model number and s is an ASCII string of up to 19 characters representing the serial number. (e.g. iBUC140145-148- 080, 123456789012345)	Query from firmware Constants	CCM?	all		na	X	X	X	X	X	X	X
Get Software Version	mm.nn - where m is the major version number and nn is the minor version number	Query from firmware Constants	CCS?	all		na	X	X	X	X	X	X	X
Get IP address			CIA?	all		na	X	X	X	X	No	No	X
Set IP address	1.0.0.0 to 223.255.255.254	Sets the TCP IP address of the unit. New address takes effect after next reset.	CIA=<value>	all		192.168.1.21	X	X	X	X	No	No	X
Get Other BUC IP address			CIB?	all		na	X	X	X	X	No	No	X
Set Other BUC IP address	1.0.0.0 to 223.255.255.254 or none	Sets the TCP IP address of the Other BUC in a 1:1 redundancy configuration. This information is used to tell "this" BUC where the "other BUC" is when this BUC has to query the other BUC for status and clone commands. Query is disabled when address is none.	CIB=<value>	all		192.168.1.22	X	X	X	X	No	No	X

Table 6-9 IBUC M&C Command Set

Parameter	<value> Valid Values (See Notes Below)	Comments	Command	Burst/ CSM Mode	Config allowed if slave?	Default Value	HHT [Note 4]	RS- 232 Port	RS- 485 Port ASCII	FSK Port ASCII	RS-485 Binary(1)	FSK Port Binary(1)	Telnet Port
Get IDC Detector	0.0 to 12.5 Amps	Returns the IDC_DET voltage	CID?	all		na	X	X	X	X	No	No	X
Get IP gateway			CIG?	all		na	X	X	X	X	No	No	X
Set IP gateway	1.0.0.0 to 223.255.255.254 Must be part of subnet.	Sets the TCP IP address of the default route.	CIG=<value>	all		192.168.1.1	X	X	X	X	No	No	X
Get IP netmask			CIM?	all		na	X	X	X	X	No	No	X
Set IP netmask	8 to 30	Sets the TCP/IP netmask. (number of 1's in netmask). Takes effect after reboot	CIM=<value>	all		24	X	X	X	X	No	No	X
Get TCP Telnet Port number			CIP?	all		na	X	X	X	X	No	No	X
Set TCP Telnet Port number	1-65534	Sets the TCP port number for the TCP/IP stack to listen on for incoming telnet connections. Takes effect after reboot	CIP=<value>	all		23	X	X	X	X	No	No	X
Get external LED enable			CLE?	all		na	No	X	X	X	No	No	X
Set external LED enable	0 = Disable External LED 1 = Enable External LED	Enables or disables the external led.	CLE=<value>	all		1	No	X	X	X	No	No	X
Get Minor Alarm Mask	0xNNNN where The bits of NNNN are as follows: bits 15-13 = ignored bit 12 = ignored bit 11-8 = ignored bit 7 = TEMP ALARM bit 6 = TX INPUT LEVEL LOW bit 5 = TX INPUT LEVEL HIGH bit 4 = TX OUTPUT LEVEL LOW bit 3 = TX OUTPUT LEVEL HIGH	Returns the minor alarm flags (hexadecimal)	CM1?	all		0x16e0	X	X	X	X	No	No	X

Table 6-9 IBUC M&C Command Set

Parameter	<value> Valid Values (See Notes Below)	Comments	Command	Burst/ CSM Mode	Config allowed if slave?	Default Value	HHT [Note 4]	RS- 232 Port	RS- 485 Port ASCII	FSK Port ASCII	RS-485 Binary(1)	FSK Port Binary(1)	Telnet Port
	bit 2-0 = ignored.												
Set Minor Alarm Mask	See Get Minor Alarm Mask	Sets the Minor alarm flags (hexadecimal is accepted)	CM1=<value>	all	no		X	X	X	X	No	No	X
Get Major Alarm Mask	See Get Minor Alarm Mask	Returns the Major alarm flags (hexadecimal)	CM2?	all		0x091C	X	X	X	X	No	No	X
Set Major Alarm Mask	See Get Minor Alarm Mask	Sets the Major alarm flags (hexadecimal is accepted)	CM2=<value>	all	no		X	X	X	X	No	No	X
Get Alarm Suppressible Mask	See Get Minor Alarm Mask	Returns the alarm suppressible flags (hexadecimal)	CMS?	all		0x0078	X	X	X	X	No	No	X
Set Alarm Suppressible Mask	See Get Minor Alarm Mask	Sets the alarm suppressible flags (hexadecimal is accepted)	CMS=<value>	all	no		X	X	X	X	No	No	X

Table 6-9 IBUC M&C Command Set

Parameter	<value> Valid Values (See Notes Below)	Comments	Command	Burst/ CSM Mode	Config allowed if slave?	Default Value	HHT [Note 4]	RS- 232 Port	RS- 485 Port ASCII	FSK Port ASCII	RS-485 Binary(1)	FSK Port Binary(1)	Telnet Port
Get BUC info	private label, Model m, SN s, Firmware Ver n.nn, mmm dd yyyy, tt:tt P=p:s, LO=:s. where: private label is set using the CPL command m denotes model number, s denotes the serial number, n.nn is the software version number, mmm dd yyyy is the date of firmware, tt:tt is the time of the firmware, p:s is the power class ID, and verbose translation thereof and :s is the LO frequency ID and verbose translation thereof.	Query of BUC configuration.	COI?	all		Terrasat Comm. Inc, Model - iBUC140145-48030, SN - TE0000000, IBUC vn.nn, date, time, P=1:2W, 3:Std C,	X	X	X	X	X	X	X
Get BUC temperature	Response: COX=<value> where <value> is -50 to +100 corresponding to -50C to +100 deg. C. A value of -127 indicates Out Of range. COX=1 will return outside temperature COX=2 will return Hi Temp shutdown Threshold (degrees C). COX=100xx Will set the hi_temp_thr_offset value (xx - range 1 to 10 degrees C).	Returns INTERNAL BUC temperature read directly from BUC temperature sensor (TEMP_SNS).	COX?	all		na	X	X	X	X	X	X	X

Table 6-9 IBUC M&C Command Set

Parameter	<value> Valid Values (See Notes Below)	Comments	Command	Burst/ CSM Mode	Config allowed if slave?	Default Value	HHT [Note 4]	RS- 232 Port	RS- 485 Port ASCII	FSK Port ASCII	RS-485 Binary(1)	FSK Port Binary(1)	Telnet Port
	Default value is 5. Calibration must be enabled for this to work. COX=20000 will return the Highest temperature in the calibration table, and the hi_temp_thr_offset all in degrees C.												
Enter Password	00001 - 65535	If superuser password entered, superuser mode is entered. If main password entered, then normal operation is enabled. If read only password entered (1111) then read only mode entered.	CPE=<value>	all		na	X	X	X	X	No	No	X
Set Private Label	Any Alpha Numeric String up to 19 characters.	Returns the private label company information (e.g. Terrasat Inc.)	CPL=<value>	all		Terrasat Comm. Inc.	No	X	X	X	No	No	X
Set Password	00001 - 65535	Only sets the main password. Superuser password is function of serial number. Read only password cannot be changed.	CPS=<value>	all	no	1234	X	X	X	X	No	No	X
Get Password Timeout		Returns value of the password timeout.	CPT?	all		na	X	X	X	X	No	No	X
Set Password Timeout	0 to 65535 (in minutes)	A zero value indicates the timeout is disabled. Otherwise the system will clear the	CPT=<value>	all	no	0	X	X	X	X	No	No	X

Table 6-9 IBUC M&C Command Set

Parameter	<value> Valid Values (See Notes Below)	Comments	Command	Burst/ CSM Mode	Config allowed if slave?	Default Value	HHT [Note 4]	RS- 232 Port	RS- 485 Port ASCII	FSK Port ASCII	RS-485 Binary(1)	FSK Port Binary(1)	Telnet Port
		passwd_recvd flag if a command is received after this amount of inactivity. Every command received updates the timer.											
Get DRO Tuning Voltage	0.0-10.0 Volts	Returns the TUNE_VOLTS voltage	CTV?	all		na	X	X	X	X	No	No	X
Get VDC detector	0.0 to 60.0 volts DC	Returns the VDC_DET voltage	CVD?	all		na	X	X	X	X	No	No	X
Get Web Page Refresh Rate		Returns value of the web page auto refresh variable	CWR?	all		na	No	X	X	X	No	No	X
Set Web Page Refresh Rate	0 to 3600 (in seconds)	A zero value indicates refresh is disabled. Otherwise the system will refresh the web page every CWR seconds.	CWR=<value >	all	no	0	No	X	X	X	No	No	X
System Reset	czz=2 Reset all vars including ethernet addresses and passwords and reboots. Does not reset model numbers, serial numbers or cal values. czz=1 Reset only int_values [], and reboots. This is handy when that array has changed format, but you really don't want to wipe out the Ethernet info!! czz=0 (or czz) Reboot machine.	Resets all BUC parameters to the default values.	CZZ	all		na	X	X	X	X	No	No	X
Disconnect Telnet		Used to disconnect a Telnet session if your or kill a hung Telnet connection.	DCN	all		na	X	X	X	X	No	No	X

Table 6-9 IBUC M&C Command Set

Parameter	<value> Valid Values (See Notes Below)	Comments	Command	Burst/ CSM Mode	Config allowed if slave?	Default Value	HHT [Note 4]	RS- 232 Port	RS- 485 Port ASCII	FSK Port ASCII	RS-485 Binary(1)	FSK Port Binary(1)	Telnet Port
Get Echo Enable		Returns state of Echo Enable flag	EKO?	all		na	No	X	X	X	No	No	X
Set Echo Enable	1=On or 0=Off	Specifies whether BUC should echo back results of Set commands, or be discretely silent	EKO=<value>	all	no	1	No	X	X	X	No	No	X
Backup Mode													
Get Redundancy Switching Type	0=Redund Not enabled, 1,Master=Redund Enabled, Buc is Master. 1,Slave = Redund Enabled, Buc is Slave	Gets the redundancy configuration of the BUC.	BAE?	all		na	X	X	X	X	No	No	X
Get Redundancy Mode	0=Revert, 1=NonRevert	Returns the redundancy mode.	BAM?	all		na	X	X	X	X	No	No	X
Set Redundancy Mode	0=Revert, 1=NonRevert	Sets the redundancy mode of operation. Operation is as follows: In reverting mode, BUC in position A (acting as a slave) can take over for a failed BUC in position B (who was acting as a master). In non reverting mode, BUC A (slave) will NOT take over for a failed BUC in position B (acting as a master). In BOTH modes, BUC B (acting as a slave) will take over for a failed BUC A (who was acting as a master). Redundancy must be enabled for this to work.	BAM=<value>	all	no	0	X	X	X	X	No	No	X
Get BUC	0=A, 1=B	Gets the redundancy	BAP?	all		na	X	X	X	X	No	No	X

Table 6-9 IBUC M&C Command Set

Parameter	<value> Valid Values (See Notes Below)	Comments	Command	Burst/ CSM Mode	Config allowed if slave?	Default Value	HHT [Note 4]	RS- 232 Port	RS- 485 Port ASCII	FSK Port ASCII	RS-485 Binary(1)	FSK Port Binary(1)	Telnet Port
Position on Switch		position of the BUC. Tells you what side of the switch this BUC is attached to. THIS COMMAND DOES NOT TELL YOU THE POSITION OF THE SWITCH - USE BSW FOR THAT.											
Set BUC Position on Switch	0=A, 1=B	Sets the Redundancy Position of the BUC with respect to the waveguide switch. This command tells the BUC which switch port he is attached to (A or B). I.E. If the BUC is PHYSICALLY attached to Switch position A, the one would issue the command BAP=0 to this BUC and BAP=1 to the other BUC (because it would be attached to position B). This is normally ONLY used at initial system setup/configuration and thereafter never used again. THIS COMMAND DOES MOVE THE SWITCH - USE BSW FOR THAT.	BAP=<value>	all	no	0	X	X	X	X	No	No	X
Get Autocloning	Returns state of autocloning		BCL?	all		na	X	X	X	X	No	No	X

Table 6-9 IBUC M&C Command Set

Parameter	<value> Valid Values (See Notes Below)	Comments	Command	Burst/ CSM Mode	Config allowed if slave?	Default Value	HHT [Note 4]	RS- 232 Port	RS- 485 Port ASCII	FSK Port ASCII	RS-485 Binary(1)	FSK Port Binary(1)	Telnet Port
Set Autocloning	0 = Disable, 1=Enable	When Autocloning is enabled, the MASTER BUC will periodically update the SLAVE BUC with configuration data. NOTE a slave with BCL=0, will still become a clone of master and BCL will become 1. Configuration data includes C4D, C4M, C4R, C4V, CPS, CPT, EKO, CM1, CM2, CMS, BAM (always cloned), BSM (always cloned), BCL (always cloned), TAH, TAL, TAZ, TBH, TBL, TBN, TBT, TFR, TGC, TPM, TSD, TSP, TST, TTS.	BCL=<value>	all	no	1	X	X	X	X	No	No	X
Get Redundancy Switching Type	0=Manual, 1=Automatic	Gets the redundancy switching type of the BUC.	BSM?	all		na	X	X	X	X	No	No	X
Set Redundancy Switching Type	0=Manual, 1=Automatic	Gets the redundancy switching type of the BUC. If switching type is automatic, then the BUC will control the switch as described in BAM. If Manual, then redundancy switching is disabled - ie only the user can change the switch.	BSM=<value>	all	no	1	X	X	X	X	No	No	X
Get Syst Status	BUCA=Auto or Manual, OnLine or Standby or Faulted BUCB=Auto or Manual, OnLine or Standby or Faulted	Returns summary status of BUCA, BUCB, and switch.	BST?	all		na	X	X	X	X	No	No	X

Table 6-9 IBUC M&C Command Set

Parameter	<value> Valid Values (See Notes Below)	Comments	Command	Burst/ CSM Mode	Config allowed if slave?	Default Value	HHT [Note 4]	RS- 232 Port	RS- 485 Port ASCII	FSK Port ASCII	RS-485 Binary(1)	FSK Port Binary(1)	Telnet Port
	SWITCH=A or B or Faulted												
Get Switch Position	0=A, 1=Bee	Returns current redundancy switch position. I.E. If the switch is in position A, then this command will return 0.	BSW?	all		na	X	X	X	X	No	No	X
Set Switch Position	0=A, 1=B	Sets the switch to position indicated. Requires Redundancy mode to be in Manual Mode.	BSW=<value>	all		na	X	X	X	X	No	No	X
Transmit													
Get Output Transmit Alarm High Threshold		Returns Output high power level threshold	TAH?	all		na	X	X	X	X	No	No	X
Set Output Transmit Alarm High Threshold	0.0-60.0 (corresponding to 0.0 to 60.0 dBm in 0.1 dB steps). Further qualified by ODU output range of P1dB to P1dB-20dB. Must be above Low Threshold.	Sets Output high power Level threshold. A level alarm is set if the threshold is exceeded.	TAH=<value>	all	no	P1dB + 1	X+-	X	X	X	No	No	X
Get Output Transmit Alarm Low Threshold		Returns Output low power level threshold	TAL?	all		na	X	X	X	X	No	No	X
Set Output Transmit Alarm Low Threshold	0.0-60.0 (corresponding to 0.0 to 60.0 dBm in 0.1 dB steps). Further qualified by ODU output range of P1dB to P1dB-20dB (Must be below High Threshold)	Sets Output low power Level threshold. (same as TAH except low threshold)	TAL=<value>	all	no	P1dB - 20	X+-	X	X	X	No	No	X
Get Transmit Alarm Simulation			TAS?	all		na	X	X	X	X	No	No	X

Table 6-9 IBUC M&C Command Set

Parameter	<value> Valid Values (See Notes Below)	Comments	Command	Burst/ CSM Mode	Config allowed if slave?	Default Value	HHT [Note 4]	RS- 232 Port	RS- 485 Port ASCII	FSK Port ASCII	RS-485 Binary(1)	FSK Port Binary(1)	Telnet Port
Set Transmit Alarm Simulation	1=On or 0=Off	Places alarm relay into "faulted" state and sets bit in alarm Byte. (See CAS?)	TAS=<value>	all		0	X	X	X	X	No	No	X
Get Transmit Alarm Suppression		Returns current value Alarm Suppression	TAZ?	all		na	X	X	X	X	No	No	X
Set Transmit Alarm Suppression	1=On or 0=Off	Suppresses all Level Alarms. All other alarms are still operational	TAZ=<value>	all	no	0	X	X	X	X	No	No	X
Get Input Transmit Alarm High Threshold		Returns Input high power level threshold	TBH?	all		na	X	X	X	X	No	No	X
Set Input Transmit Alarm High Threshold	-15.0 to -55.0 dBm (0.1 dB steps). (Must be above Low Threshold)	Sets Input high power Level threshold. BUC Controller continuously reads the input detector voltage. Compares the Input power to this threshold. A level alarm is set if the threshold is exceeded.	TBH=<value>	all	no	-15	X+	X	X	X	No	No	X
Get Input Transmit Alarm Low Threshold		Returns Input low power level threshold	TBL?	all		na	X	X	X	X	No	No	X
Set Input Transmit Alarm Low Threshold	-15.0 to -55.0 dBm (0.1 dB steps). Must be below High Threshold	Sets Input low power Level threshold. (same as TBH except low threshold)	TBL=<value>	all	no	-60	X+	X	X	X	No	No	X
Get Burst Count			TBN?	all		na	X	X	X	X	X	X	X
Set Burst Count	1 to 16	Sets the number of points to average in the burst power measurement	TBN=<value>	all	no	8	X+	X	X	X	X	X	X
Get Burst Threshold		Returns the burst power threshold.	TBT?	all		na	X	X	X	X	X	X	X

Table 6-9 IBUC M&C Command Set

Parameter	<value> Valid Values (See Notes Below)	Comments	Command	Burst/ CSM Mode	Config allowed if slave?	Default Value	HHT [Note 4]	RS- 232 Port	RS- 485 Port ASCII	FSK Port ASCII	RS-485 Binary(1)	FSK Port Binary(1)	Telnet Port
Set Burst Threshold	0.0-60.0 (corresponding to 0.0 to 60.0 dBm in 0.1 dB steps). Further qualified by ODU output range of P1dB to P1dB-20dB	Sets the threshold for burst power measurement in the SSPA. All output power measurements above this power level are considered to be measurements taken when burst is present and are averaged into burst power level.	TBT=<value>	all	no	P1dB - 20	X++	X	X	X	X	X	X
Get Input Power Sensor Reading		Returns the current input power level in dBm.	TDT?	all		na	X	X	X	X	No	No	X
Get Tx Frequency Band		Returns the frequency band for the ODU.	TFB?	all		na	X	X	X	X	X	X	X
Get Spectral Inversion		Reads from LO Frequency ID table the spectral inversion flag based on which frequency band the unit is set for.	TFI?	all		na	X	X	X	X	No	No	X
Get Transmit Frequency		Returns the RF frequency. This value is used internally to determine which elements to use in the calibration tables.	TFR?	all		na	X	X	X	X	X	X	X
Set Transmit Frequency	950-1525 or 5850-14500. If the former range, input is assumed to be at IF. Conversion to RF must be performed. If the latter, no conversion is necessary.	Used to determine what point to use in the output power detector calibration table.	TFR=<value>	all	no	Middle of Tx Band	X	X	X	X	X	X	X

Table 6-9 IBUC M&C Command Set

Parameter	<value> Valid Values (See Notes Below)	Comments	Command	Burst/ CSM Mode	Config allowed if slave?	Default Value	HHT [Note 4]	RS- 232 Port	RS- 485 Port ASCII	FSK Port ASCII	RS-485 Binary(1)	FSK Port Binary(1)	Telnet Port
Get Auto Level/Gain Control		Returns the state of the ALC/AGC logic	TGC?	all		na	X	X	X	X	No	No	X
Set Auto Level/Gain Control	Mode:0=Off (open loop), 1=ALC, 2=AGC.	Turns on AGC or ALC or disables both.	TGC=<value>	all	no	0	X	X	X	X	No	No	X
Get Auto Level/Gain Calibration State		Returns the target gain and target level of the AGC calibration. A -99.99 dB (m) value indicates the function is not calibrated.	TGL?	all		na	X	X	X	X	No	No	X
Get Gain Control		Returns the current gain control (from AGC/ALC) setting.	TGR?	all		na	X	X	X	X	No	No	X
Reset Gain Control	0 is only valid value	Resets the Gain control attenuator to midscale with corresponding change in gain through device. Use with caution as the gain will change.	TGR=0	all	no	0	X	X	X	X	No	No	X
Get Transmit Power Read Mode		Reports which field is being read.	TPM?	all		na	X	X	X	X	No	No	X
Set Transmit Power Read Mode	0=CSM (Continuous Signal Mode) or 1=Burst	Determines which Power fields to read from the ODU when queried.	TPM=<value>	all	no	0	X	X	X	X	No	No	X
Get Output Transmit Power Level	Response: -99 = out of range, 0/w 0.00 to 60.00 (dBm) (resolution is 1/100 dB)	Returns current transmit output power.	TPO?	all		na	X	X	X	X	X	X	X
Get Tx Atten Setting		Returns the current dB gain setting of the VVA	TPT?	all		na	X	X	X	X	No	No	X
Set Tx Atten Setting	0 to 16.0 dB. Units are in dB, 0.1dB steps	Sets the Voltage Variable Attenuator (VVA) to the value specified.	TPT=<value>	all	no	0	X+	X	X	X	No	No	X

Table 6-9 IBUC M&C Command Set

Parameter	<value> Valid Values (See Notes Below)	Comments	Command	Burst/ CSM Mode	Config allowed if slave?	Default Value	HHT [Note 4]	RS- 232 Port	RS- 485 Port ASCII	FSK Port ASCII	RS-485 Binary(1)	FSK Port Binary(1)	Telnet Port
Get Transmit Power Up Delay		Returns value of Transmit Power Up Delay.	TSD?	all		na	X	X	X	X	No	No	X
Set Transmit Power Up Delay	0 to 500 in 1 sec. steps.	Sets transmit Power Up delay to selected duration. Delay timer is only used on power up. Turn TX off until delay completed, then turn on if appropriate.	TSD=<value>	all	no	0	X+	X	X	X	No	No	X
Get Transmit state at BUC power Up		Reports State at Pwr Up	TSP?	all		na	X	X	X	X	No	No	X
Set Transmit state at BUC power Up	1=On, or 0=Off	Set transmitter to this state at power up.	TSP=<value>	all	no	1	X	X	X	X	No	No	X
Get MUTE state		Reports whether MUTE is asserted or not.	TST?	all		na	X	X	X	X	X	X	X
Set MUTE state	1=Transmitter On, or 0=Transmitter Off	Turns on or off the SSPA.	TST=<value>	all	no	1	X	X	X	X	X	X	X
Get BUC High Temp Shutdown		Returns the value of the high temp shutdown enable/disable.	TTS?	all		na	X	X	X	X	X	X	X
Set BUC High Temp Shutdown	1=Enables or 0=Disables	Enables or Disables the high temp shutdown when temperature exceeds ratings. A zero disables the automatic shutdown. Caution when setting this to zero as the unit can be damaged.	TTS=<value>	all	no	1	X	X	X	X	X	X	X
Alarm/Temp Log History													
Monitor Alarm History	Alarm Flag, CR, LF for the last (up to) 100 alarms in order as they occurred.	Returns an ASCII string for each record in history. String format is	AHI?	all		na	X	X	X	X	No	No	X

Table 6-9 IBUC M&C Command Set

Parameter	<value> Valid Values (See Notes Below)	Comments	Command	Burst/ CSM Mode	Config allowed if slave?	Default Value	HHT [Note 4]	RS- 232 Port	RS- 485 Port ASCII	FSK Port ASCII	RS-485 Binary(1)	FSK Port Binary(1)	Telnet Port
		0xLLLL where LL is the hexadecimal representation of the flag for the alarm. (See note 7 and Table 3)											
Clear Alarm History	none	Clears alarm buffer.	AHZ	all		na	X	X	X	X	No	No	X
Get Temp Log	A comma separated three-tuple: saaa,sbbb,nnnnn where s is an optional sign, aaa is the minimum temperature in degrees C, bbb is the maximum temperature, and nnnnn is the number of writes to temp. log.	Returns the min/max/count temperature log.	ATL?	all		na	X	X	X	X	X	X	X

Table 6.10: Alarm flags

Transmit flags	
0x0001	AGC or ALC out of range
0x0002	AGC or ALC not settled
0x0004	BUC loss-of-lock
0x0008	Tx Output Level Hi alarm
0x0010	Tx Output Level Low alarm
0x0020	Tx Input Level Hi alarm
0x0040	Tx Input Level Low alarm
0x0080	Temperature Alarm
0x0100	Tx Simulated fault
0x0200	10 MHz Reference Alarm
0x0400	VDC Out Of Range
0x0800	Waveguide Switch Fault
0x1000	Not Used
0x2000	IDC Out of Range alarm
0x4000	AGC/ALC Target Out of Range
0x8000	Not Used

Misc flags	
0x0001	Error-log pointers corrupted
0x0002	Fault in restoring config data
0x0004	Ethernet Download Alarm
0x0008	Serial Download Alarm
0x0010	Reboot Alarm
0x0020	Clone Communications Error
0x0040	Clone Read Fault
0x0080	Clone Write Fault

- 6) M&C using TCP/IP is displayed in embedded web pages. The user connects to the IBUC M&C and enters the IBUC IP address through a web browser. This will bring up a login page. After login, the operator has a choice of six web pages with monitoring, control and alarm information. Below you'll find a snapshot of the Login page and all other six pages:

Login page:

Type the password in the box and click the Login button to Login. The default value is 1234.



The screenshot shows a web page with the following elements:

- Logo:** TERRASAT Communications, Inc. with a red arc above the text.
- Page Title:** IBUC M&C Webpage
- Section:** Login
- Timestamp:** *This page generated: Wed Mar 29 14:17:32 2006*
- Form:** A horizontal line above the text "Please enter password:" followed by a text input box and a "Login" button.
- Footer:** Copyright © 1999 - 2005 Terrasat Communications, Inc.

Figure 6-3 Login Page

Alarm Status page:

This page allows the operator to verify the alarm status of the unit. The green background shows that the parameter is OK. Minor faults will have an orange background and major faults will have a red background. Refer to Table 6-1 to find out which alarms are user configurable and what the default configuration is. At the bottom of the page the operator will be able to access the Alarm History log and clear it by clicking the clear button.



IBUC M&C Webpage

Menu Options:

- [Alarm Status](#)
- [Transmit Status](#)
- [Transmit Config](#)
- [Interface Config](#)
- [System Config](#)
- [Alarm Config](#)

This page generated: Wed Mar 29 14:19:56 2006

[Logout](#) [Refresh](#)

<i>Serial Number</i>	TE5010943
<i>Model Number</i>	IBUC058064-148010
<i>Firmware Version</i>	FW IBUC v0.84, Tue Jan 31 2006 14:50:54
<i>Power Class</i>	10 W
<i>Frequency Band</i>	C-Band Standard
<i>Temperature (Internal)</i>	46 °C
<i>10 MHz Detector</i>	Ok
<i>Supply Voltage</i>	47.7 V
<i>Current Consumption</i>	1.7 A
<i>Power Consumption</i>	78.7 W
<i>PLDRO Lock Voltage</i>	5.78 V
<i>PLDRO Lock</i>	Ok
<i>ALC Range</i>	N/A
<i>AGC Range</i>	N/A
<i>TX Input Level</i>	Ok
<i>TX Output Level</i>	Ok
<i>Alarm History</i>	<input type="button" value="Clear"/> View history

Copyright © 1999 - 2005 Terrasat Communications, Inc.

Figure 6-4 Alarm Status page

Refer to Table 6-9 IBUC M&C Command Set for information regarding parameters and valid values.

Transmit Status page:

This page allows the operator to verify if the transmission is enabled, the frequency set for power monitor purposes, mode of operation, attenuator status, input and output levels, etc. The green background shows that the parameter is OK. Minor faults will have an orange background and major faults will have a red background. Refer to Table 6-1 to find out which alarms are user configurable and what the default configuration is.



IBUC M&C Webpage

Menu Options:

- Alarm Status
- Transmit Status
- Transmit Config
- Interface Config
- System Config
- Alarm Config

This page generated: Wed Mar 29 14:21:22 2006

[Logout Refresh](#)

<i>Serial Number</i>	TE5010943
<i>Model Number</i>	IBUC058064-148010
<i>Firmware Version</i>	FW IBUC v0.84, Tue Jan 31 2006 14:50:54
<i>Power Class</i>	10 W
<i>Frequency Band</i>	C-Band Standard

<i>TX Output</i>	Enabled
<i>TX Frequency</i>	6137 MHz
<i>TX Gain Mode</i>	Open Loop
<i>TX Gain Control</i>	0.0
<i>TX Attenuation</i>	0.0
<i>TX Input Level</i>	-34.21 dBm
<i>TX Output Level</i>	39.03 dBm
<i>TX Input Threshold Low</i>	Ok
<i>TX Input Threshold High</i>	Ok
<i>TX Output Threshold Low</i>	Ok
<i>TX Output Threshold High</i>	Ok
<i>Power Read Mode</i>	CSM
<i>TX Powerup Delay</i>	0 sec
<i>TX Powerup State</i>	Enabled
<i>High Temp Shutdown</i>	Enabled
<i>Simulate TX Fault</i>	Disabled
<i>Suppress TX Fault</i>	Disabled

Copyright © 1999 - 2005 Terrasat Communications, Inc.

Figure 6-5 Transmit Status page

Refer to Table 6-9 IBUC M&C Command Set for information regarding parameters and valid values.

Transmit Config page:

This page allows the operator to configure the transmission. After changing a setting, the operator has to click the update button for that particular block of parameters.



IBUC M&C Webpage

Menu Options:

- Alarm Status
- Transmit Status
- Transmit Config
- Interface Config
- System Config
- Alarm Config

This page generated: Wed Mar 29 14:22:23 2006

[Logout Refresh](#)

Serial Number	TE5010943
Model Number	IBUC058064-148010
Firmware Version	FW IBUC v0.84, Tue Jan 31 2006 14:50:54
Power Class	10 W
Frequency Band	C-Band Standard

Update TX Settings	<input type="button" value="Update"/>
TX Output	Enabled <input type="button" value="v"/>
TX Frequency	6137 MHz
TX Powerup State	Enabled <input type="button" value="v"/>
TX Powerup Delay	0 sec
High Temp Shutdown	Enabled <input type="button" value="v"/>
Power Read Mode	CSM <input type="button" value="v"/>
Burst Threshold	20.00 dBm
Burst Count	8

Reset TX Gain Control	<input type="button" value="Reset"/>
-----------------------	--------------------------------------

Update TX Alarm Settings	<input type="button" value="Update"/>
TX Gain Mode	Open Loop <input type="button" value="v"/>
TX Attenuation	0.0
Simulate TX Fault	Disabled <input type="button" value="v"/>

Update TX Alarm Settings	<input type="button" value="Update"/>
TX Input Threshold Low	-60.00 dBm
TX Input Threshold High	-15.00 dBm
TX Output Threshold Low	20.00 dBm
TX Output Threshold High	41.00 dBm
Suppress TX Fault	Disabled <input type="button" value="v"/>

Copyright © 1999 - 2005 Terrasat Communications, Inc.

Figure 6-6 Transmit Config page

Refer to Table 6-9 IBUC M&C Command Set for information regarding parameters and valid values.

Interface Config page:

This page allows the operator to configure the interfaces (TCP/IP or RS-485/FSK). It also allows the operator to set the Webserver refresh rate. When set to 0 sec, the Webpage will **not** be refreshed.



IBUC M&C Webpage

Menu Options:

- Alarm Status
- Transmit Status
- Transmit Config
- Interface Config
- System Config
- Alarm Config

This page generated: Wed Mar 29 14:23:16 2006

[Logout Refresh](#)

<i>Serial Number</i>	TE5010943
<i>Model Number</i>	IBUC058064-148010
<i>Firmware Version</i>	FW IBUC v0.84, Tue Jan 31 2006 14:50:54
<i>Power Class</i>	10 W
<i>Frequency Band</i>	C-Band Standard

<i>Update Interface Settings</i>	<input type="button" value="Update"/>
<i>IP Address</i>	192.168.1.23
<i>IP Subnet Mask</i>	255.255.255.0
<i>Gateway Address</i>	192.168.1.1
<i>Webserver Auto Refresh</i>	0 sec
<i>Telnet TCP Port</i>	23
<i>Other BUC IP Address</i>	192.168.1.22
<i>RS-485/FSK Address</i>	1

<i>Update Serial Settings</i>	<input type="button" value="Update"/>
<i>Baud Rate</i>	9600 <input type="button" value="v"/>
<i>RS-485/FSK Mode</i>	Legacy Binary <input type="button" value="v"/>
<i>Verbose Messages</i>	Disabled <input type="button" value="v"/>
<i>Echo</i>	Enabled <input type="button" value="v"/>

Copyright © 1999 - 2005 Terrasat Communications, Inc.

Figure 6-7 Interface Config page

Refer to Table 6-9 IBUC M&C Command Set for information regarding parameters and valid values.

System Config page:

This page allows the operator to set the System Password and the Password Timeout. It also allows the user to Reset (reboot) the Controller card .



TERRASAT
Communications, Inc.

IBUC M&C Webpage

Menu Options:
Alarm Status
Transmit Status
Transmit Config
Interface Config
System Config
Alarm Config

This page generated: Wed Mar 29 14:23:58 2006

[Logout](#) [Refresh](#)

<i>Serial Number</i>	TE5010943
<i>Model Number</i>	IBUC058064-148010
<i>Firmware Version</i>	FW IBUC v0.84, Tue Jan 31 2006 14:50:54
<i>Power Class</i>	10 W
<i>Frequency Band</i>	C-Band Standard

<i>Update Password Settings</i>	<input type="button" value="Update"/>
<i>System Password</i>	<input type="text"/>
<i>Password Timeout</i>	<input type="text" value="0"/> min

<i>System Reset</i>	<input type="button" value="Reset"/>
---------------------	--------------------------------------

Copyright © 1999 - 2005 Terrasat Communications, Inc.

Figure 6-8 System Config page

Refer to Table 6-9 IBUC M&C Command Set for information regarding parameters and valid values.

Alarm Config page:

This page allows the operator to configure the alarms as Minor, Major or None. Major alarms are the ones that cause a summary alarm (relay closure) with the Form-C relay. This is particularly important when operating in redundancy. Summary alarms are the ones that will cause switchovers. It also allows operator to configure alarms as suppressible. Suppressible alarms are the ones that will be suppressed when enabling "Suppress Tx Fault" (see Transmit Config page).



IBUC M&C Webpage

Menu Options:

- Alarm Status
- Transmit Status
- Transmit Config
- Interface Config
- System Config
- Alarm Config

This page generated: Wed Mar 29 14:24:34 2006

[Logout](#) [Refresh](#)

<i>Serial Number</i>	TE5010943
<i>Model Number</i>	IBUC058064-148010
<i>Firmware Version</i>	FW IBUC v0.84, Tue Jan 31 2006 14:50:54
<i>Power Class</i>	10 W
<i>Frequency Band</i>	C-Band Standard

<i>Update Alarm Flags</i>	<input type="button" value="Update"/>
<i>Temperature Alarm</i>	MINOR ▾
<i>TX Input Threshold Low</i>	MINOR ▾
<i>TX Input Threshold High</i>	MINOR ▾
<i>TX Output Threshold Low</i>	MAJOR ▾
<i>TX Output Threshold High</i>	MAJOR ▾

<i>Update Alarm Flags</i>	<input type="button" value="Update"/>
<i>Temperature Alarm Suppressible</i>	Disabled ▾
<i>TX Input Threshold Low Suppressible</i>	Enabled ▾
<i>TX Input Threshold High Suppressible</i>	Enabled ▾
<i>TX Output Threshold Low Suppressible</i>	Enabled ▾
<i>TX Output Threshold High Suppressible</i>	Enabled ▾

Copyright © 1999 - 2005 Terrasat Communications, Inc.

Figure 6-9 Alarm Config page

Power Measurement

The Terrasat IBUC is capable of accurately reading the input and output power for a single carrier in either Continuous Signal Mode (CSM) or Burst mode. The dynamic range for the input power is from -60 to -15 dBm and for the output power is from rated power to 20dB below rated power. Each unit is loaded with a detector calibration lookup table that compensates for detector variations in frequency, power level and temperature. The reported power level is then based on the user-requested frequency and the internal monitored temperature and power level. If multiple carriers are present the composite transmit power level is read but accuracy is dependent upon actual carrier frequencies, levels and modulation being used.

The power measurement is done in two ways:

1) Burst Mode

- In the Burst power measurement mode it is assumed that in normal operation a transmit carrier may or not be present due to the nature of Burst mode operation. Since the transmit burst pulse has a rise time and a fall time the power must be reported as an average value. To maintain detected accuracy of the burst pulse, 16 consecutive measurements of the pulse are taken (all values below the power threshold setting are ignored). The 8 lowest values are then dropped and the remaining 8 values averaged. The memory is then automatically updated and the value is ready to be reported. Refer to Figure 6-10.
- Burst Time: 500us to 1s
- Measurement accuracy: +/- 2 dB absolute, 1.5dB p-p relative. Accuracy is improved as the detected burst threshold level is raised closer to the carrier peak.
- The detector accuracy is based on a pulsed unmodulated signal with a pulse width of 500us.

2) Continuous Signal Mode (CSM)

- In the CSM power measurement mode it is assumed that in normal operation a transmit carrier is always present. Therefore, reported power is the actual measured power at the time of query.
- Measurement accuracy: +/- 1 dB absolute, 1 dB p-p relative*
- The detector accuracy is based on a CW unmodulated carrier.

* Relative measurement accuracy defines the error between any two power readings at any particular frequency over the dynamic range.

Notes:

- To make the given accuracy achievable, the operating transmit frequency information must be provided via M&C in order to utilize the information in the detector calibration look up table.

By default the unit will be set to perform CSM measurements.

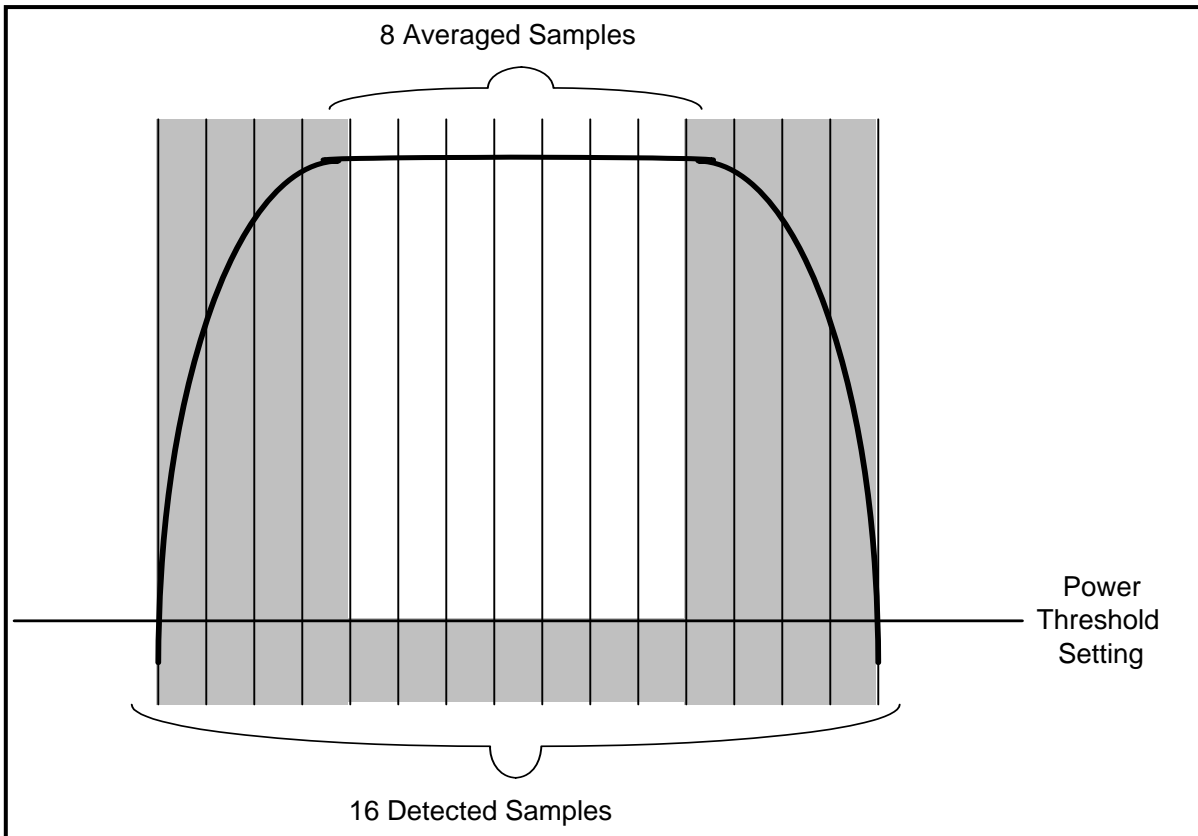

Figure 6-10 Burst Power Measurement

Chapter 7 IBUC Redundant Systems

Introduction

The IBUC can be installed and configured as a redundant system providing automatic switching to a standby unit in the event of failure of an online unit. A companion receive redundant system is also available for protection of LNBs. The receive redundant system has a separate interface controller but shares the DC power supplies used by the transmit redundant system IBUC's. The power supply for Redundant Systems is available in two versions: indoor rack-mount and outdoor types. The 200W hot-swappable dual Power Supply (indoor rack-mount) is housed in a Standard 1RU (19 inches rack) and powers Low Power Tx (up to 12W) and Rx Redundant Systems. The outdoor PSUI's come in a weatherproof housing and can power all of the Terrasat Redundant Systems.

Description

Figure 7-1 is a diagram of a typical redundant system.

A redundant transmit system includes two IBUC's of the same frequency band connected to an interface box and an RF switch. An external power supply, PSUI-524, PSUI-548 or PSUI-648, is required for each IBUC. Low power Redundant Systems can also be powered by an indoor rack-mount Dual Power Supply, PSUI-1024 (24VDC) or PSUI-1048 (48VDC). The IBUC's, interface box, and RF switch are typically mounted on a common mounting plate and connected with supplied cables and waveguide components. The system provides automatic switching between IBUC's in the event of failure. The IBUC's communicate with each other to monitor status and execute switching logic. A software command is available in the IBUC to enable the unit designated master, to clone itself to the slave to match the unit configuration. Monitor and Control functions are available through the interface box via Hand Held terminal (one connector for each IBUC), RS232 (one connector for each IBUC, same as HHT), RS485 (user interface connector), TCP/IP (user interface connector), and FSK (coaxial connection), as in the individual IBUC's. In the redundant system, remote M&C via RS485 and TCP/IP is done via the interface box which eliminates the need to run two separate M&C cables to the IBUCs. In the case of FSK, M&C is available on the IFL cable and no additional cable is required. M&C commands for redundancy systems are already resident in the IBUC software (see Table 6-9, Chapter 6).

The receive redundancy system provides for switching of LNBs via a separate receive interface box. Switching is accomplished using a waveguide switch that switches the RF receive signal and a RF relay (internal to the Interface box) that switches the IF signal. M&C is available via hand held terminal, RS232, RS485, and TCP/IP at the user interface port on the RX interface box.

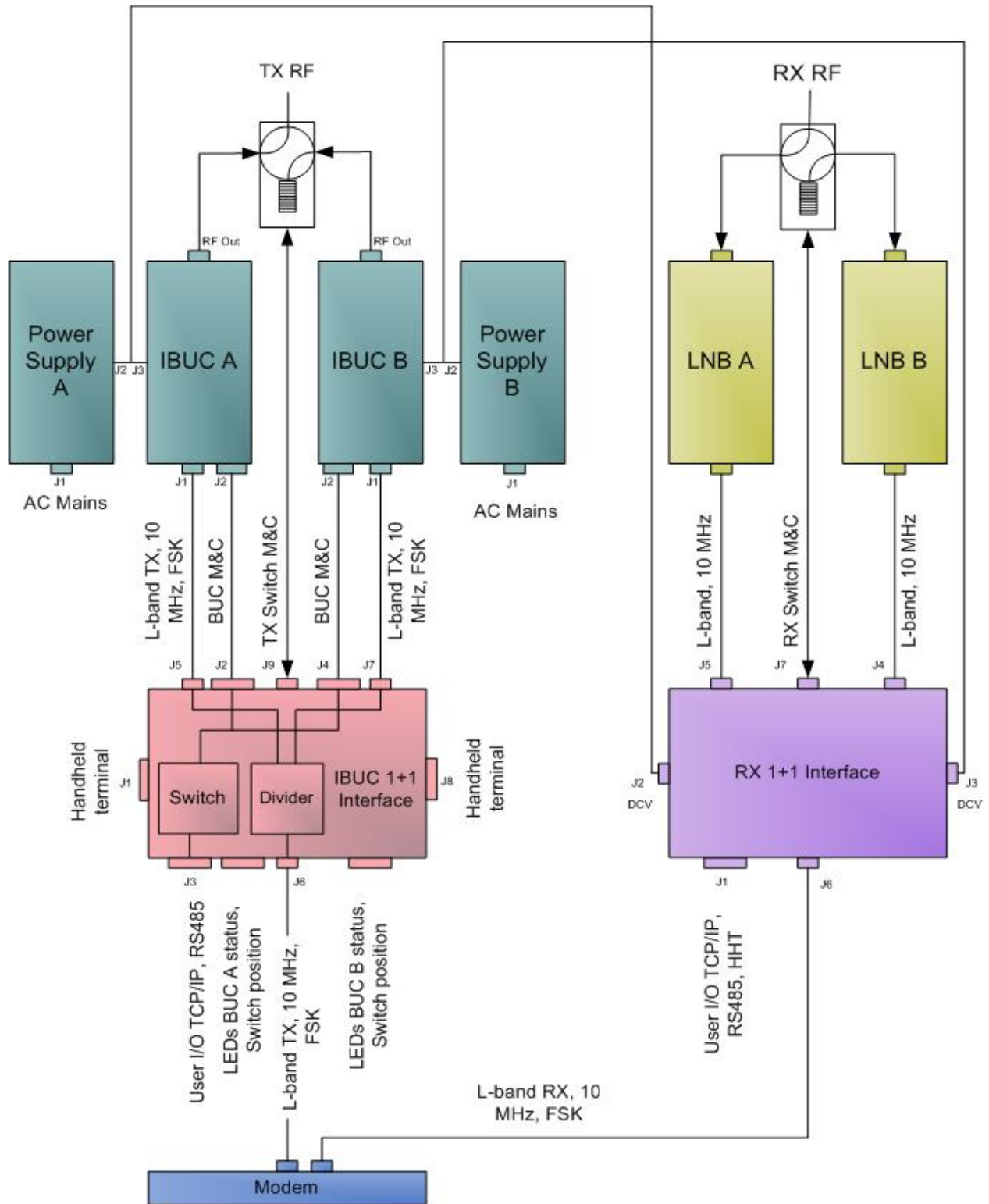

Note: Low Power Systems can be powered by an indoor 200W hot-swappable dual Power Supply.

Figure 7-1. IBUC Redundant System

Component Descriptions

As described earlier the redundant transmit system includes two IBUC's of the same frequency band connected to an interface box at the input and an RF switch. An external power supply, PSUI-524, PSUI-548 or PSUI-648, is required for each IBUC. Low power Redundant Systems can also be powered by an indoor rack-mount Dual Power Supply, PSUI-1024 (24VDC) or PSUI-1048 (48VDC). This section explains the functionality of each component and their interrelationships.

Intelligent Block Up-converter (IBUC)

Refer to Chapter 3.

Tx 1+1 Interface Module

Refer to the Tx 1+1 Interface Module block diagram on page 7-4.

The Tx 1+1 Module is powered by both IBUC's through connectors J2 (IBUC A) and J4 (IBUC B). Both supply inputs feed a linear regulator that generates the voltage for all internal circuitry. The RS-232 interface, the power for the Handheld terminal and the alarm output (normally open; faulted: short to ground) from IBUC A & B are routed to connectors J1 (IBUC A) and J8 (IBUC B). The RS-485 interface coming from both IBUC's (connectors J2 and J4) are connected together and routed to the User Interface (connector J3). The Ethernet ports from IBUC A & B (connectors J2 and J4) are routed to the User Interface (connector J3) through an internal Ethernet switch. The Alarm Output of IBUC A is routed to the Alarm Input of IBUC B and vice-versa. This way, IBUC A & B monitor each other. The switch command from IBUC A & B are connected together and routed to the Waveguide Switch connector (J9). The Waveguide switch indicators (connector J9) are routed to both IBUC's (connectors J2 and J4). The Tx Input (L-band, 10MHz and FSK) from connector J6 is routed to a splitter (it also blocks DC, if present at J6). The outputs of the splitter are routed to connector J5 (Tx output A) and J7 (Tx output B). The Tx 1+1 module also has a bank of LED's that provide a visual indication of the power (green if it's OK), Ethernet activity for IBUC A, IBUC B and User Interface, and status of both IBUC's, as well as which IBUC is online.

Tx 1+1 Interface Module Block Diagram

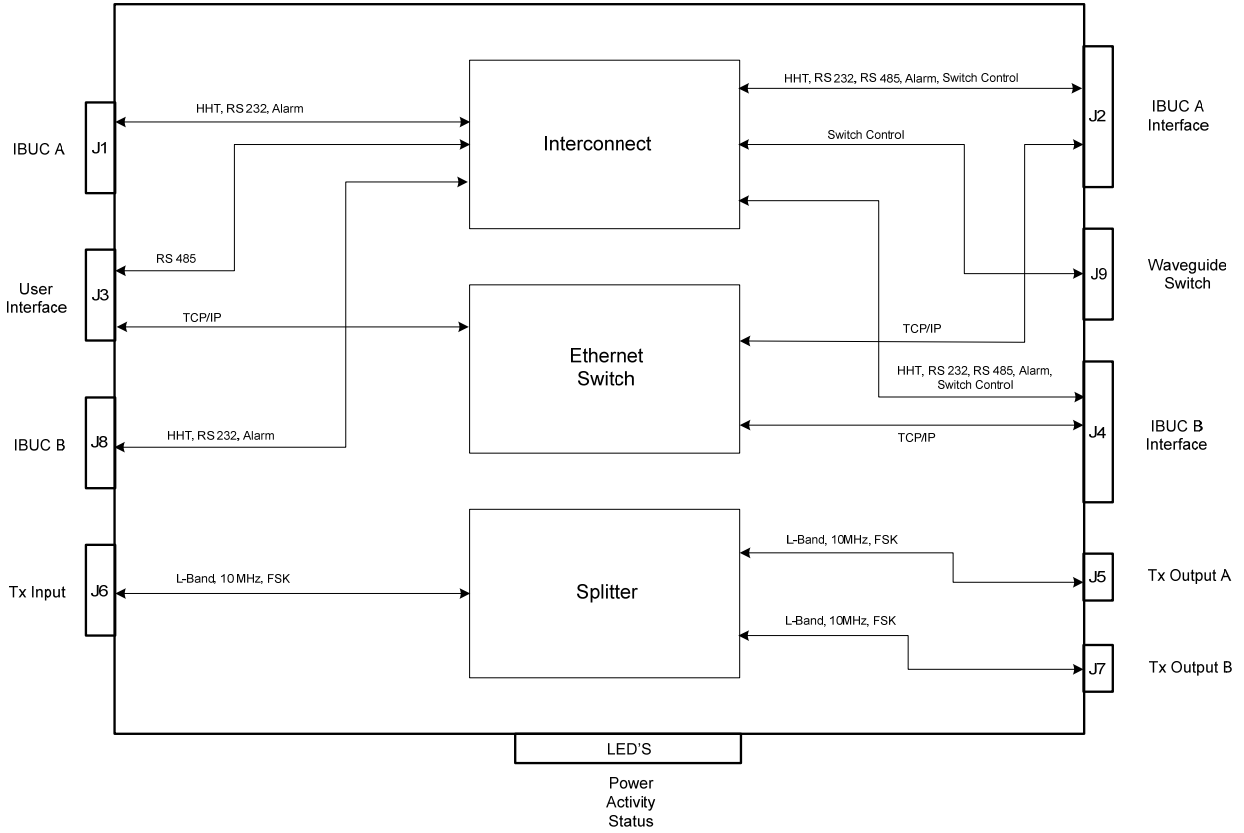

Figure 7-2 Tx 1+1 Interface Module Block Diagram

Low Noise Block Converter (LNB)

See Chapter 3.

Rx 1+1 Interface Module

Refer to Rx 1+1 Interface Module block diagram on page 7-6.

DC Supply

The Rx 1+1 Module is supplied with a voltage from 20 to 60VDC through connector J2 (from the power supply that powers IBUC A) and connector J3 (from the power supply that powers IBUC B). Power Supply A is routed to a DC/DC that generates the voltage that supplies LNB A and Power Supply B is routed to a DC/DC that generates the voltage that supplies LNB B. Both Power Supplies are routed to a DC/DC that generates the voltage that supplies all internal circuitry.

Monitor and Control

The Rx 1+1 Interface Module is equipped with monitor and control (M&C) capabilities. There are five ways to remotely access the M&C capabilities of the Interface. First is via the M&C 19-pin circular connector (J1) utilizing two wire RS485. In order to access the RS485, a separate cable must be run and connected to J1. A second way to access M&C is through the same J1 connector using RS-232. In order to access the RS-232, a separate cable must be run and connected to J1. A third way to access the M&C is through the same J1 connector using TCP/IP. This method requires a separate Ethernet cable. The fourth method is through the same J1 connector using an optional handheld terminal. The fifth way to access the M&C capabilities remotely is through the L-band output N-connector (J6) utilizing Frequency Shift Keying (FSK). Using this method requires no additional cable but does require that the FSK be multiplexed onto the L-band cable. Modem manufacturers do not offer yet built in FSK capabilities capable of communicating with the Rx 1+1, but the unit is ready for it when that happens. Later in this chapter you'll find specific information on command structure and commands for this module. The Rx 1+1 Interface Module also provides status alarm output (Form-C relay) for both LNB's.

L-Band Signal Flow

The L-band inputs to the Rx 1+1 Interface Module are through the input N-connectors J5 (LNB A) and J4 (LNB B). The online signal is selected through a RF switch (relay) and routed to J6 (L-band Rx out) through the mux / de-mux circuitry. Samples of both L-band inputs (LNB A & B) are detected and sent to the M&C card for monitor purposes. The 10 MHz reference from the modem (J6) is de-multiplexed and split to feed both LNB's. The 10MHz level is detected and sent to the M&C card for alarm processing. The DC supply (+18VDC) generated internally and the 10 MHz reference are multiplexed to the L-band signal to feed the LNB's through connector J5 and J4. Before multiplexing the DC voltages, the current and voltage that are fed to the LNB's are detected and the information is sent to the M&C card.

Power Supply Units (PSUI)

Outdoor PSUI

See Chapter 3 for Outdoor PSUI's (PSUI-524, PSUI-548 and PSUI-648).

Indoor PSUI

The 200W hot-swappable dual Power Supply (indoor rack-mount) can power Low Power Tx and Rx Redundant Systems. The PSUI converts the universal AC input (100-240VAC) to 24VDC or 48 VDC to power the IBUC's and the Rx 1+1 Interface Module. The AC input to the PSUI is routed through P1. There are two power supplies, each with its own power entry module. Both the live and the neutral inputs are fused in the power entry module for maximum protection and routed to the internal AC/DC module. The DC output is routed to connector J1. Each power supply has a cooling fan. An LED on the front panel of both supplies indicates when the power supply is in operation.

Waveguide Switch

Redundant Systems are provided with the waveguide switch. The switch cable, used to connect the Tx and Rx Interface to the switch is also included.

Software

Both Tx and Rx Redundant Systems monitor and control several parameters and have features that make installation and use of the Redundant Systems simpler as well as enhancing system performance. For a full description of M&C functions, refer to Chapter 6 for Tx redundancy and M&C Functions section on page 7-35 for Rx redundancy.

Some of the key features include;

Monitor and Control – the Redundant Systems may be monitored and controlled through RS-232, RS-485, Ethernet port, an optional handheld terminal or via an FSK link with compatible modems.

Tx Redundancy – The IBUC's sense automatically when they are configured in Redundancy. The logic for redundant operation is built-in, which eliminates the need of an external switching controller.

Autocloning – The Master IBUC (online) periodically updates the Slave IBUC (standby) with configuration data. It allows the operator to configure the system by configuring only the Master IBUC. Slave will become a "clone" of the Master when Autocloning is enabled.

Rx Redundancy – It monitors not only the Voltage and current to the LNB, but also the L-band composite input level, improving the fault detection.

Embedded Webpage – provides management for small networks using a web browser.

Alarm History – a log of all alarms that occur is maintained. This simplifies troubleshooting of the system especially if an intermittent problem occurs.

Installation & Setup

The Terrasat ODU consists of a Tx 1+1 Redundant System, and could include an Rx 1+1 Redundant System, Redundant Power Supplies and a set of interconnection cables. The Terrasat IDU consists of a hot-swappable dual Power Supply (indoor rack-mount).

This section contains the general requirements for installation of the ODU to the antenna and the IDU.

WARNING:

- ***FOR PROTECTION OF PERSONNEL AND EQUIPMENT, USE CARE WHEN INSTALLING THE ANTENNA AND WHENEVER WORKING ON OR AROUND THE SYSTEM.***
- ***TAKE STANDARD SAFETY PRECAUTIONS WITH HAND AND/OR POWER TOOLS.***
- ***USE CARE IN WORKING WITH DANGEROUS VOLTAGES.***

Unpacking

Check to make sure that the ODU has not suffered damage in shipment. If damage is noticed contact Terrasat customer support.

Compare the contents of the shipping container with the packing list to ensure all items have been received. If any item is determined to be missing contact Terrasat customer support.

Retain all shipping containers for future use.

Installing the Outdoor Unit (ODU)

Tools and Test Equipment

Have on hand a standard electrician's tool kit and any tools listed in the antenna manufacturer's installation instructions.

Site Considerations

The ODU is designed to mount on the antenna. Locate and install the antenna according to instructions supplied by the antenna manufacturer. Choose an area that is free of extraneous interference from motors and electrical equipment and has a clear line of sight from the antenna to the satellite. Lightning arrestors should be used at the site to protect personnel and equipment. Size 3/0 or 4/0 AWG stranded copper wire should be used to ground the Tx Redundancy, Redundant PSUI and the Rx Redundancy to the antenna frame and to the lightning protection ground rod. For the higher power units with an external power supply provide an isolation filter to reduce power line interference as required.

Preparation

Mounting Considerations:

Optional Mounting Brackets are available that will facilitate mounting for most antennas.

The ODU must be mounted such that:

- Sufficient support is afforded to the Tx Redundancy, the Rx Redundancy and the Redundant PSUI's to minimize the effects of antenna sway in strong winds.
- Air movement across the heat fins is possible.
- The fan shroud (IBUC and PSUI) is mounted so that the louvers are facing the ground.
- The fan intake and exhausts are free from any obstruction.
- The length of the PSUI cables is taken into consideration in determining the mounting location of the PSUI.

Throughout installation and during any polarization, azimuth or elevation adjustment, ensure that cables and waveguide are not crimped or pinched.

Power Requirements



Installation and connection to the line power supply must be made in compliance with applicable wiring codes and regulations.



Ensure AC power is off prior to disconnecting PSU power cord. Turn off AC power to the unit using installed circuit breaker or similar disconnecting device.



After turning AC power source off, disconnect Power Cord from PSU before servicing the unit.

The IBUC's can be supplied directly through the external power connector (J3). Refer to the label on the unit to determine whether 24 or 48 Volts is required. Ensure that the 24VDC input voltage is between 20 and 28VDC and that the 48VDC input is between 37 and 60VDC.

For IBUC's with a rated power of 16 watts or greater, an outdoor power supply is required. Terrasat offers a 400W outdoor PSUI (good for all power levels up to 40W C-band or 25W Ku-band) and a 700W outdoor PSUI (good for all power levels up to 80W C-band and 40W Ku-band). Power supplies have an auto ranging AC front end that will work with both 115VAC and 230VAC.

All outdoor PSUI's are equipped with a detachable AC power connector. When connecting the AC connector to the AC source the wiring must include a 15 or 20 amp circuit breaker. A disconnect device that is readily accessible must also be provided. Any outdoor AC connection should be made using suitable connectors or boxes with an IEC protection class of at least IP65.

The outdoor PSUI is shipped with mating connectors for the AC mains power cable. In order to remain compliant with European Low Voltage Directive (EN 60950), use a power cable that meets IEC 60227 requirements such as HAR Cable Designation H03 VV-F or H03 VVH2 -F and/or others with water resistance for outdoor applications. Power cable plugs must also meet national/local standards.

If a circuit breaker is not easily accessible as a disconnecting device, the input connector will be the disconnecting device. In this case, the socket-outlet must be installed near the equipment and must be easily accessible for pluggable equipment.

NOTE: AC transients and surges can cause data transmission errors and loss of sync in the modem and/or the ODU. Proper precautions should be taken to ensure uninterrupted service.

Antenna Mounting

Mounting Brackets are available to facilitate attachment to antennas. Generic mounting instructions for the Tx Redundancy, Rx Redundancy and the Redundant PSU's are given below.

After the antenna has been installed the Terrasat ODU may then be mounted on the antenna. Mount the equipment as follows;

The Tx Redundancy can be mounted on the antenna back structure or in the hub depending on the antenna type. The Tx Redundancy plate has mounting holes on both sides of the unit that can be used to attach the system to the antenna. Refer to chapter 9 for the mounting hole dimensions.

The Redundant PSU's will typically mount on the antenna back structure or the hub of an antenna. The PSU plate has mounting holes can be used to attach the PSU to the antenna. Refer to chapter 9 for mounting hole dimensions.

The LNB's are mounted directly to the Waveguide switch at the focal point of the antenna. Ensure that proper gasketing is used when mounting the waveguide switch and the LNB, and the LNB to the OMT.

Installing the Indoor PSU

Tools and Test Equipment

Have on hand a standard electrician's tool kit.

Mounting Location

The Terrasat Dual Power Supply dimensions are 19-inch rack width, 1RU-rack high (1.75 inches), and 11.1 inches deep. Refer to chapter 9 for detailed dimensions. Allow a minimum of 6 inches (15 cm) between the back of the chassis and the end of the rack for cable clearance.

The PSU may be rack-mounted or placed on a flat surface. If the PSU is to be rack-mounted, a rack shelf or tray is recommended.

Access/Airflow

Adequate space must be reserved for air movement, cable connections, and equipment access. Do not block the airflow on the sides of the chassis. Without sufficient air cooling, the unit may overheat.

AC Power Connection

The PSU is designed to work at 100 - 240 VAC, 47 - 63 Hz. The PSU must be grounded through the AC power cable (standard 3-prong equipment connection).

Current and voltage surges in the AC power input can be reduced by installing surge protectors and AC power line filters.

Note: AC transients and surges can cause data transmission errors.

To ensure uninterrupted service, some method of backup AC power is recommended.

An un-interruptible power supply (UPS) is preferred, along with a power stabilizer or an isolation filter to ensure clean power.

System Cabling Requirements

Interfaces

TX System – IBUC's A and B each connect to the interface box via a coax cable connection (J1) carrying L-band, 10MHz reference and FSK M&C signals where appropriate. A second connector on the IBUC (J2) connects to the interface box providing M&C interface. IBUC waveguide outputs are connected to ports on the TX RF switch using waveguide bends. DC Power (48VDC) is provided from separate power supplies to each IBUC at J3.

The TX waveguide switch provides the uplink signal to the antenna feed via waveguide (customer supplied) or coax cable as required. Power and switching control are carried on an interface cable from the switch to the interface box.

The interface box provides nine connectors for interfacing the IFL, IBUC's RF switch and M&C. Status LED's are built in to the interface box providing visual system status. Remote M&C for the 1+1 system is available via separate M&C cables using RS485 or TCP/IP. Systems with FSK-capable modems also have M&C available at the modem front panel. Local M&C is available with a hand held terminal connected at the interface box.

Tx 1+1 Interface Module

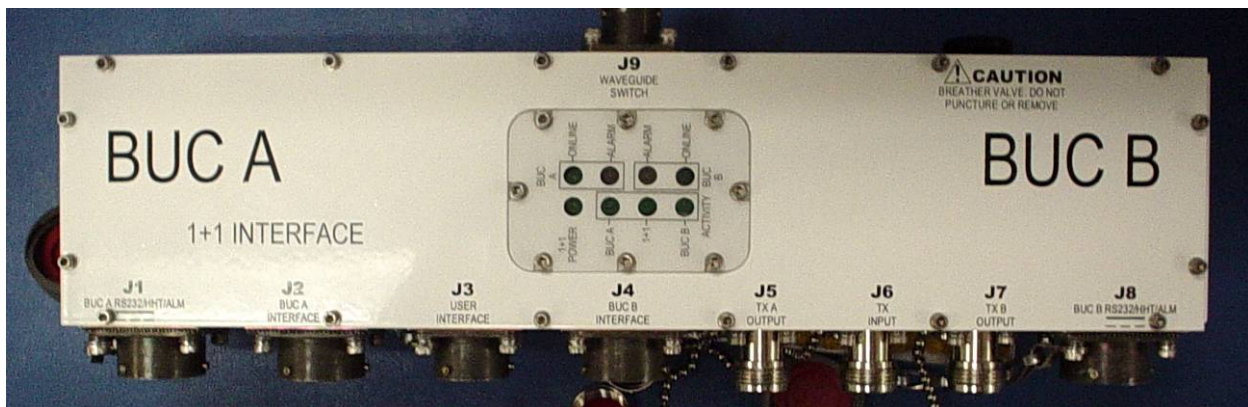

Figure 7-4 Tx 1+1 Interface Module Top View

Physical Connections

Table 7-1 Tx 1+1 Interface Module

Tx 1+1 INTERFACE MODULE CONNECTOR SCHEDULE			
REF DESIG	FUNCTION	CONNECTOR	CONNECTOR MATE
J1, J8	RS232, HHT & ALARM	AMPHENOL CYLINDRICAL, BOX MTG RCPT, 19S (MS3112E-14-19S)	AMPHENOL CYLINDRICAL, STRAIGHT PLUG, 19P (MS3116F-14-19P)
J2, J4	M&C INTERFACE	AMPHENOL CYLINDRICAL, BOX MTG RCPT, 19P (MS3112E-14-19P)	AMPHENOL CYLINDRICAL, STRAIGHT PLUG, 19S (MS3116F-14-19S)
J3	USER INTERFACE	AMPHENOL CYLINDRICAL, BOX MTG RCPT, 8P (MS3112E-12-8P)	AMPHENOL CYLINDRICAL, STRAIGHT PLUG, 8S (MS3116F-12-8S)
J5, J7	Tx OUT	TYPE-N, RCPT	TYPE-N, PLUG
J6	Tx IN	TYPE-N, RCPT	TYPE-N, PLUG
J9	WG SWITCH CONTROL / INDICATOR	AMPHENOL CYLINDRICAL, BOX MTG RCPT, 6S (MS3112E-10-6S)	AMPHENOL CYLINDRICAL, STRAIGHT PLUG, 6P (MS3116F-10-6P)

A mating M&C connector for J3 is provided with the Tx 1+1 System.

Terrasat offers a 700W outdoor PSUI (good for IBUC's with all power levels up to 80W C-band or 40W Ku). Power supplies have an auto-ranging AC front end that will work with both 115VAC and 230VAC. The outdoor PSUI is shipped with a DC power cable (10ft) and mating connectors for the AC mains power cable.

RS232, HHT & Alarm J1 and J8: The RS232, HHT & Alarm connector is a 19-pin, circular, female connector used to allow monitoring and control of the IBUC's operating parameters. Pin assignments are shown below. J1 allows monitoring and control of BUC A and J8 allows monitoring and control of BUC B.

Table 7.2 RS232, HHT & Alarm Connectors J1 and J8, Pin Assignments

Tx 1+1 INTERFACE MODULE: J1, J8	
PI N	FUNCTION
A	N/C
B	N/C
C	HANDHELD TERMINAL POWER (+)
D	RS232 RXD
E	RS232 TXD
F	HHT, RS232 Common
G	N/C
H	N/C
J	N/C
K	N/C
L	IBUC ALARM OUTPUT Normally Open
M	GND
N	N/C
P	N/C
R	N/C
S	N/C
T	N/C
U	N/C
V	N/C

M&C Interface J2 and J4: The M&C Interface connectors are 19-pin, circular, male connectors used to allow the IBUC's to exchange communication and status, as well as monitor and control the WG switch. Pin assignments are shown below. The M&C cables used to connect the Tx 1+1 Interface Module and the IBUC's are supplied with the Tx 1+1 System.

Table 7.3 M&C Interface Connectors J2 and J4, Pin Assignments

Tx 1+1 INTERFACE MODULE: J2, J4	
PI N	FUNCTION
A	RS485 (+)
B	RS485 (-)
C	HANDHELD TERMINAL POWER (+)
D	RS232 RXD
E	RS232 TXD
F	HHT, RS232 Common
G	TCP/IP TX+
H	TCP/IP TX-
J	TCP/IP RX+
K	TCP/IP RX-
L	IBUC ALARM OUTPUT Normally Open
M	IBUC ALARM OUTPUT Common
N	IBUC ALARM INPUT
P	IBUC ALARM OUTPUT Normally Closed
R	1+1 SWITCH COMMAND A
S	1+1 SWITCH COMMAND B
T	1+1 SWITCH INDICATOR A
U	1+1 SWITCH INDICATOR A
V	1+1 REDUNDANCY ENABLE

User Interface J3: The User Interface connector is an 8-pin, circular, male connector used to allow remote monitoring and control of the Tx 1+1 System operating parameters. Pin assignments are shown below. If the User Interface port of the Tx 1+1 Interface Module is going to be used the cable should be a shielded multi-conductor cable with at least two each twisted pairs. The twisted pairs used for TCP/IP must have an impedance of 100 ohms. Please also see the IP cable drawing attached. An assembled IP cable is available from Terrasat.

Table 7-4 User Interface Connector J3, Pin Assignments

Tx 1+1 INTERFACE MODULE: J3	
PIN	FUNCTION
A	RS485 (+)
B	RS485 (-)
C	COMMON
D	TCP/IP TX+
E	TCP/IP TX-
F	TCP/IP RX+
G	TCP/IP RX-
H	NC

Transmit Out J5 and J7: The TX OUT connectors are Type N, female connectors used to connect the IF at L-Band from the Tx 1+1 Interface Module to the IBUC's. 50Ω cables should be used to connect to J5 and J7. These cables are supplied with the Tx 1+1 System. The Tx 1+1 Interface Module also supplies the IBUC's the FSK signal and the 10MHz reference connectors J5 and J7.

Transmit In J6: The TX IN connector is a Type N, female connector used to connect the IF at L-Band from the Modem. 50Ω cables should be used to connect to J6. The Modem also supplies through this connector the FSK signal and the 10MHz reference for the IBUC's.

WG Switch Control / Indicator J9: The WG Switch Control / Indicator connector is a 6-pin, circular, female connector used to allow the Tx 1+1 System to control and monitor the WG Switch. The cable that connects the Tx 1+1 Interface Module and the WG Switch is supplied with the System.

IBUC connections

Refer to Chapter 4, pages 4-5 through 4-8.

Power Supply Connections

Refer to Chapter 4, pages 4-8 through 4-10.

RX System – A receive redundancy interface box provides interfaces for the LNBs and switch control for the RX waveguide switch. M&C is available via a single connector using RS232, RS485 or TCP/IP for remote M&C or hand held terminal for local control.

The interface box also provides DC power connectors receiving 24 or 48VDC from external power supplies.

RX 1+1 Interface Module:



Figure 7-5 RX 1+1 Interface Module Front Panel



Figure 7-6 RX 1+1 Interface Module Back Panel



Figure 7-7 RX 1+1 Interface Module Side View

Physical Connections

Table 7.5 Rx 1+1 Interface Module

Rx 1+1 INTERFACE MODULE CONNECTOR SCHEDULE			
REF DESIG	FUNCTION	CONNECTOR	CONNECTOR MATE
J1	USER INTERFACE	AMPHENOL CYLINDRICAL, BOX MTG RCPT, 19S (MS3122E14-19S)	AMPHENOL CYLINDRICAL, STRAIGHT PLUG, 19P (MS3116F14-19P)
J2, J3	DC POWER	MS CIRCULAR CONN, BOX MTG RCPT, (MS3102R10SL-4P)	MS CIRCULAR CONN, STRAIGHT PLUG (MS3106F10SL-4S)
J4, J5	Rx IN	TYPE-N, RCPT	TYPE-N, PLUG
J6	Rx OUT	TYPE-N, RCPT	TYPE-N, PLUG
J7	WG SWITCH CONTROL / INDICATOR	AMPHENOL CYLINDRICAL, BOX MTG RCPT, 6S (MS3122E10-6S)	AMPHENOL CYLINDRICAL, STRAIGHT PLUG, 6P (MS3116F10-6P)

A mating M&C connector for J1 is included with the Rx 1+1 System. The Rx 1+1 Interface Module DC Power is supplied directly through the external power connectors (J2 and J3). The Power Supply can have voltages from 20 to 60 VDC.

Terrasat offers a 600W outdoor PSUI (good for IBUC's with all power levels up to 80W C-band or 40W Ku). Power supplies have an auto-ranging AC front end that will work with both 115VAC and 230VAC. The PSUI's used to supply the Tx 1+1 System can be shared with the Rx 1+1 System. Terrasat supplies one "Y" adapter for each PSUI together with the Rx 1+1 System that allows the user to connect the supply cables to the Rx 1+1 Interface Module.

User Interface J1: The M&C Interface is a 19-pin, circular, female connector used to allow remote monitoring and control of the Rx 1+1 Interface Module operating parameters. Pin assignments are shown below. If the M&C port of the Rx 1+1 Interface Module is going to be used the cable should be a shielded multi-conductor cable with at least two each twisted pairs. The twisted pairs used for TCP/IP must have an impedance of 100 ohms. Please also see the IP cable drawing attached. An assembled IP test cable is available from Terrasat.

Table 7.6 User Interface Connector J1, Pin Assignments

Rx 1+1 INTERFACE MODULE: J1	
PIN	FUNCTION
A	RS485 (+)
B	RS485 (-)
C	HANDHELD TERMINAL POWER (+)
D	RS232 RXD
E	RS232 TXD
F	HHT, RS232 Common
G	TCP/IP TX +
H	TCP/IP TX -
J	TCP/IP RX +
K	TCP/IP RX -
L	LNB-A ALARM OUTPUT Normally Open
M	LNB-A ALARM OUTPUT Common
N	LNB-A ALARM OUTPUT Normally Closed
P	LNB-B ALARM OUTPUT Normally Open
R	LNB-B ALARM OUTPUT Common
S	LNB-B ALARM OUTPUT Normally Closed
T	N/C
U	N/C
V	N/C

DC Power J2 and J3: Prime power is supplied to the Rx 1+1 Interface Module through 2-pin circular female connectors.

Table 7.7 Power Connectors J2 and J3, Pin Assignments

Rx 1+1 INTERFACE MODULE: J2 and J3	
PIN	FUNCTION
A	VDC COMMON
B	VDC +

Receive In J4 and J5: The RX IN connectors are Type N, female connectors used to connect the IF at L-band from the LNB's to the Rx 1+1 Interface Module. 50Ω cables are supplied with the Rx 1+1. The Rx 1+1 Interface Module supplies the LNB's the 10MHz reference and VDC through these connectors.

Receive Out J6: The RX OUT connector is a Type N, female connector used to connect the IF at L-band to the Modem. 50Ω cables should be used to connect to J6. The Modem supplies through this connector the 10MHz reference signal for the LNB's.

Power Supply Connections

Refer to Chapter 4, pages 4-8 through 4-10.

Note: Rx 1+1 Systems include a “Y” adapter that allows the user to share the Power Supplies with the Tx 1+1 System.

Table 7-8 “Y” Adapter Connector Schedule

Y ADAPTER J1		Y ADAPTER J2		Y ADAPTER J3	
MS3106F14S-6P		MS3101F14S-6S		MS3101F10SL-4S	
PIN	FUNCTION	PIN	FUNCTION	PIN	FUNCTION
A	VDC-	A	VDC-		
B	VDC-	B	VDC-		
C	VDC-	C	N/C	A	VDC-
D	VDC+	D	N/C	B	VDC+
E	VDC+	E	VDC+		
F	VDC+	F	VDC+		

Cable and Waveguide Connections

WARNING: Ensure that all power is disconnected prior to making the following connections

When installing the cable and waveguide assemblies ensure that all connections are weather-tight. If the optional RX reject filter has been ordered attach it to the Tx Redundancy waveguide output. Ensure that proper gasketing is used to prevent water damage.

Waveguide connection:

Connect a section of flexible waveguide between the OMT transmit port and the Tx Redundancy TX RF Output (or optional RX reject filter). The waveguide should be attached to the antenna feed per the manufacturer's instructions. Ensure that proper gasketing is used to prevent water damage.

Typical Configuration:

Connect the IFL coaxial cable between the Tx 1+1 Interface Module J6 (TX L-band In) and the Modem.

Connect the coaxial cable between the Rx 1+1 Interface Module J6 (RX L-band) and the Modem L-band RX INPUT.

Connect the M&C cable between the Tx 1+1 Interface Module J3 (User Interface) and the appropriate M&C computer or LAN connection.

Connect the DC cable between the outdoor PSU's J2 (DC Output), as appropriate, and the IBUC A and B J3 (DC Input).

Connect the AC cable between the PSU's J1 (AC Input) and the AC power source.

Water Resistant Wrap

The application of moisture resistant wrap (mastic tape) to all outdoor connectors is recommended to prevent water entry and resultant water damage. Apply the mastic tape as follows:

- Ensure that all connectors are tight.
- Pre-cut the mastic tape to the desired size.
- Center the tape on the connector to be sealed and wrap the tape tightly around the connector. Squeeze the tape tightly and ensure that both ends of the tape have formed around the connector and the cable.
- Apply the tape to all connectors that may be exposed to moisture.

Grounding

Antenna Recommendations

Most antenna masts are encapsulated in concrete. Typically, the mast pipe is submerged in a 4 (1.22m) to 5 foot (1.53m) deep augured hole. This provides a good Ufer ground. An Ufer ground, in this case, is defined such that concrete retains moisture for 15 to 30 days after rain or snow melt. Concrete absorbs moisture quickly, yet retains moisture for a period of time. The concrete's large volume and great area of contact with the surrounding soil allows a good transfer to the ground.

In the concrete base, an Ufer ground can be established by running a #4 gauge solid wire or rebar and connecting with pigtailed to the base of the pedestal.

The Ufer ground is only one step in proper grounding. The Ufer ground should be augmented with coupled pairs of 10 foot (3.05m) rods, placed 20 feet (6.1m) into the ground, spaced 20 feet (6.1m) apart. The first rod should be placed close to the antenna. The second rod should be placed towards the equipment enclosure. A #2 gauge wire should connect the rods and antenna mount. A ground rod should be placed at the equipment enclosure as well. If it is virtually impossible to install the ground rods, then radials are needed. This can be accomplished by laying 10 or more lengths of 1 1/2-inch (3.81cm) copper strap, at least 50-feet (15.24m) long, in a radial fashion around the antenna base. The straps should be buried, if possible. The hub must be interconnected to the utility ground.

The ground configuration can vary from one location to another. It is best to measure the soil conductivity and design a 5 ohm ground system. To protect the system from a direct strike, a lightning rod placed 2 feet (61 cm) higher than the highest point of the dish should be interconnected to the Ufer ground with #2 gauge copper wire.

Tx/Rx Redundancy / PSUI Grounding Recommendations

Grounding and lightning protection is recommended as follows.

Cable Shielding: The shield currents can be eliminated with proper techniques. A grounding strap at the end of the coaxial and data cables should be connected to the ground lug at the antenna base with a #4 gauge copper wire. This provides a path of least resistance prior to entering the electronic equipment.

AC: The best way to protect the equipment is to have two protectors. The first is the power mains protector that is mounted directly across the mains in the breaker box. The second should be mounted or grounded directly at the base or hub of the antenna or at the 19 inch rack.

Data and Control Lines: The I/O lines can deliver surge current to the equipment and should be protected as well.

Electrical grounding: Grounding of the IBUC and PSU units is recommended to prevent possible damage from lightning and/or other induced electrical surges. It is recommended that 3/0 or 4/0 AWG (American Wire Gauge) stranded copper wire be used to bond the IBUC and the PSU to the earth ground (grounding rod), using the most direct (shortest) route.

SYSTEM ALIGNMENT and OPERATION

General

The sections below outline the procedure for setup and alignment of the earth station. Prior to the ODU alignment, the antenna should be set to the desired azimuth and elevation settings per manufacturer's instructions.

CAUTION: THE Tx Redundant System MUST NOT TRANSMIT UNTIL ALIGNMENT AND ANY NECESSARY ADJUSTMENTS ARE COMPLETE.

Test Equipment

The following equipment or equivalent is recommended for installation and system alignment:

Table 7-9 Recommended Test Equipment

Equipment	Type
Spectrum Analyzer	HP8563E
Digital Voltmeter	Fluke 8050
Adapter Waveguide to coax	C or Ku-band
RF cables	With calibrated insertion loss up to 15GHz
40 dB attenuator	High Power to match HPA output.
Assortment of cables, connectors and adapters (calibrated up to 15 GHz)	

Ensure that the TX output power is disabled to prevent accidental transmission interference with adjacent satellites or transponders before attempting to align or performing any other operation involving the ODU. Before attempting any system change, carefully evaluate the possible effects of the transmitted signal.

Setting the TX and RX Frequencies

All transmit and receive frequencies are set in the modem.

For a direct connection to an L-band modem follow the manufacturer's instructions on setting the transmit and receive frequencies.

Receive L-band Output Measurements

To check the Receiver, perform the following:

- Ensure that 15-24VDC (LNB Bias) is present at the Rx 1+1 Interface Module RX inputs A and B.
- Use a spectrum analyzer to ensure that the 10MHz signal is present at the modem RX input.

Warning; DC power will be present on the cable so the use of a DC block is recommended.

- Connect the Rx 1+1 Interface Module to the demodulator RX input by attaching the coaxial cables from the RX L-band OUT (J6) on the Interface to the demodulator RX L-band input port.

Antenna Alignment

WARNING: WHEN ALIGNING THE ANTENNA, THE IBUC MUST NOT TRANSMIT.

Ensure that the desired transponder is in operation. To find the satellite and peak the receive signal, perform the following:

- Apply power to the Rx 1+1 Interface Module.
- Sweep the antenna through previously determined azimuth and elevation adjustments. Note: This must be done very slowly in order to locate the satellite.
- Simultaneously, monitor the RECEIVE signal level at the demodulator. Wideband signals such as video carriers are easiest to find and should be used when available.
- Tune the antenna and adjust its polarization according to the antenna manufacturer's instructions until the satellite is found.

TX Power Alignment

Transmit L-band Input Adjustment with Modem or Converter

Warning; DC power may be present on the cable so the use of a DC block is recommended when performing the following steps.

To set the power level of the modulator output:

- With a spectrum analyzer, measure the power level of the L-band signal at the output of the coaxial cable that connects to the Tx 1+1 Interface Module at J6 (TX L-band).
- Use the modem or converter level adjust to increase and decrease the power level. Adjust this for a level of -24 dBm (this will result in rated power at the IBUC output).
- Check that the 10MHz reference signal is between +3 and -12 dBm.
- Disconnect the spectrum analyzer from the coaxial cable.

Transmit RF Output Adjustment with Modem or Converter

To adjust the power level of the IBUC transmitter output:

- Connect a waveguide to coax adapter and a 40dB high power attenuator to waveguide output.
- Connect the TX L-band input signal to J6 (TX L-band) on the Tx 1+1 Interface Module.
- Enable the TX signals in the modem or converter and the IBUC's.
- Measure the RF output with the power meter connected at the waveguide output. For accuracy measure pure carrier.
- With a Satellite modem: Adjust the RF output to the designated power level (provided by the satellite network operation center, or its engineering staff) with the L-band output (modem) level adjust. Do this for both systems (A and B). Equalize the gains by using the gain setting control of the IBUC's. There are differences between the units and cloning doesn't transfer the attenuator settings from the Master to Slave.
- Disable the TX signal in the modem or converter.
- Disconnect the TX L-band input signal.
- Remove the waveguide to coax transition and install the transmit waveguide section to the antenna transit feed.
- Once the transmit input and output power levels have been set, begin transmitting by connecting the TX L-band input signal to J6 on the Tx 1+1 Interface Module and enabling the TX in the modem or converter.
- Under the guidance of the Network Operations Center (NOC), fine adjust the transmit power for the desired down link margin at the receiving station by adjusting the TX L-band output level adjust (modem or converter output).

Final Checks

To ensure optimum operation, inspect the system for crimped or pinched cabling. Make sure all connections are secure. Once the system has been aligned and is operating satisfactorily, it will require a few infrequent and simple maintenance procedures as described in Maintenance and Service, chapter 5.

M&C Setup

Tx System

Default values:

A SIDE IBUC:

RS485 Data Rate is 9600 baud
RS485/FSK Mode is 1 (Legacy Binary mode)
Default IP address is 192.168.1.21
Other (standby) BUC IP address is 192.168.1.22
IP gateway address is 192.168.1.1

B SIDE IBUC:

RS485 Data Rate is 9600 baud
RS485/FSK Mode is 1 (Legacy Binary mode)
Default IP address is 192.168.1.22
Other (standby) BUC IP address is 192.168.1.21
IP gateway address is 192.168.1.1

Note: RS485/FSK Mode 1 is the default setting to enable compatible modems to use the "Legacy binary" mode to communicate with the IBUC.

General

Communication with the IBUC1+1 can be accomplished via any of five interfaces: TCP/IP, RS232, RS485, Handheld Terminal (HHT), and FSK Link. The HHT/RS232 connections can be found on connector J1 for the A side unit, and connector J8 for the B side unit. The IP/RS485 connections can be found on connector J3. These can be connected to with an appropriately configured cable and terminal. FSK Link uses FSK signals between the IBUC and modem that are multiplexed on the IFL coax cable.

TCP/IP:

Communication with the IBUC via TCP/IP can be through Telnet (ASCII) or the onboard web server (HTTP). The IBUC uses a static IP addressing structure and does not support DHCP. The IBUC1+1 is factory-configured as follows:

A SIDE IBUC:

IP Address 192.168.1.21
Other BUC IP Address 192.168.1.22
IP Gateway 192.168.1.1
Subnet Mask 255.255.255.0
Telnet Port 23

B SIDE IBUC:

IP Address 192.168.1.22

Other BUC IP Address 192.168.1.21
IP Gateway 192.168.1.1
Subnet Mask 255.255.255.0
Telnet Port 23

Note: Your computer should have a static IP address on the same subnet as the IBUC1+1. Using a suitable cable, connect the computer to the IBUC1+1 J3 connector. Note: If an Ethernet hub is not used to connect to the IBUC1+1, then a crossover cable must be used. An Ethernet hub will function with a straight connect cable. Please see the attached drawing.

Telnet:

On the host computer activate a command prompt window. Enter Telnet 192.168.1.21 for the A IBUC or Telnet 192.168.1.22 for the B IBUC and a cursor should appear on the left of the screen. Type the password command, CPE=1234, and the response will be IBUC>_. Commands may now be entered to access the IBUC functionality. (Please see Operation Manual, Section 6).

Web Server:

On the host computer activate a web browser window. In the address window type [HTTP://192.168.1.21](http://192.168.1.21) and press enter. Within a few seconds you should see the login screen. On the login screen, enter 1234 in the login box and press the Login button. You will now see the A IBUC on the left side of the browser window and the B IBUC on the right side of the browser window. You will be taken to the Alarm Status page on both IBUCs where you can select from the following web pages:

- Alarm Status
- Transmit Status
- Transmit Config
- Redundant Config
- Interface Config
- System Config

The “Status” pages enable monitoring of various IBUC parameters. Alarms are color coded with green indicating OK, orange as a warning, and red as an alarm condition.

The “Configuration” pages provide access for changing factory default settings to suit specific site or network requirements. Settings take effect when you press the “Update” button. Note that some changes in configuration will cause a loss of communication with the host computer. It will then be necessary to make the corresponding change in the host computer. For an example, here are instructions on changing a unit’s IP address (using the default settings):

Navigate to the “Interface Config” page

Change the IP address to something other than 192.168.1.21 (the factory default)

Press “Update”.

Note that IP address changes take effect immediately.

In the host computer web browser type the new address and come back in through the Login page.

RS232:

No configuration of the IBUC1+1 is required for proper RS232 operation. Connect a suitable cable to connector J1 for the A IBUC and connector J8 for the B IBUC. The RS232 port uses ASCII protocol and a fixed baud rate of 9600 for communication. On the host computer set the serial port settings to the following: Baud rate to 9600, data bits to 8, parity to none, stop bits to 1, and flow control to none. The IBUC can be accessed using a terminal program on the host computer such as HyperTerminal. Hit enter several times and you should see the "IBUC>" prompt. Type CPE=1234 and the IBUC> prompt should return. The IBUC is now ready to accept commands.

Following are two examples, which use the default settings. If you need to reconfigure these settings, this describes the sequence of events:

To configure TCP/IP do the following:

A SIDE IBUC:

CIA=192.168.1.21	// IP Address
CIB=192.168.1.22	// Other IBUC IP Address
CIG=192.168.1.1	// IP Gateway
CIM=24	// Subnet Mask
CIP=23	// Telnet Port

B SIDE IBUC:

CIA=192.168.1.22	// IP Address
CIB=192.168.1.21	// Other IBUC IP Address
CIG=192.168.1.1	// IP Gateway
CIM=24	// Subnet Mask
CIP=23	// Telnet Port

To configure RS485 do the following:

A SIDE IBUC:

C4A=1	// RS485 Address
C4D=20	// RS485 Delay
C4R=9600	// RS485 Baud rate
If ASCII mode is desired type C4M=0 default)	// RS485 Mode (Not factory
If Legacy mode is desired type C4M=1	// RS485 Mode

B SIDE IBUC:

C4A=2	// RS485 Address
C4D=20	// RS485 Delay
C4R=9600	// RS485 Baud rate
If ASCII mode is desired type	

```
C4M=0                                     // RS485 Mode (Not factory
default)
If Legacy mode is desired type
C4M=1                                     // RS485 Mode
```

RS485:

Communicating with the IBUC across RS485 can be through ASCII or a proprietary binary protocol referred to as Legacy.

ASCII mode:

The default configuration is Legacy Binary mode so it will be necessary to reconfigure in order to use ASCII mode. ASCII mode can be selected via web page in TCP/IP or using HHT or RS232 to configure the 485 address (1), 485 line delay (20), 485 mode (0) and 485 baud rate (9600).

Communication through a terminal program such as HyperTerminal requires an onboard RS485 card in the host computer. In HyperTerminal type the password command: <0001/CPE=1234 for the A IBUC and <0002/CPE=1234 for the B IBUC followed by the enter key. Once the < prompt comes back the IBUC is ready to accept commands. In the above example <0001/ is the address of the IBUC followed by the desired command.

If an external box is used to convert RS232 to RS485, then a terminal program will not function. These boxes are designed to work with the RTS/CTS lines manually which a terminal program cannot handle. In these cases, a network management program is required to handle this handshaking requirement.

Legacy (binary) mode:

This is the default setting of the IBUC. In this mode the BUCMON program supplied on the CD accompanying the unit is the simplest method to communicate with the IBUC. Otherwise, a network management program must be provided.

HANDHELD TERMINAL (HHT):

No IBUC configuration is required to use the HHT. To activate the HHT, connect the supplied cable to the IBUC connector labeled J1 for the A IBUC or J8 for the B IBUC and plug the phone jack into the HHT. Once a flashing cursor is seen in the upper left part of the screen, press the decimal key on the HHT 4 times to activate the HHT. The login screen will appear. Enter the default password of 1234.

The Handheld Terminal Menu Tree is in the Operation Manual, Section 6, Figure 6.9.

FSK LINK:

Several brands of Modem have the capability to communicate with a Block Up Converter (BUC) using an FSK signal multiplexed onto the IF output connector along with the Tx IF signal and 10 MHz reference. This enables the operator to monitor and control the IBUC from the modem

front panel. The IBUC default configuration is RS485/FSK Mode 1 (Legacy Binary mode) since all modems currently require this protocol for FSK links. The IBUC is also capable of FSK communication using ASCII mode but requires a modem compatible with this method. Refer to the modem manual for commands and procedures for FSK communication with the IBUC.

A Multi-function LED is mounted on the IBUC housing to provide visual indications of IBUC status. LED colors and modes are as follows:

Flashing Green - No Alarms
Flashing Red - Minor Alarm being reported
Steady Red - Major Alarm being reported

Major and Minor alarms are defined in the IBUC manual. Note that certain alarms are configurable giving the user the ability to define them as Major or Minor alarms.

LEDs:

There are eight leds mounted on the Tx 1+1 Interface Module housing to provide visual indications of Tx 1+1 System status.

1+1 Power – indicates power is supplied to the unit.

BUC A Activity – indicates Ethernet activity on BUC A.

1+1 Activity – indicates Ethernet activity on User Interface port.

BUC B Activity – indicates Ethernet activity on BUC B.

BUC A ONLINE – indicates A side is transmitting the Tx signal to the antenna.

BUC A ALARM – Red indicates a Major alarm is present for position A. Green indicates OK.

BUC B ALARM – Red indicates a Major alarm is present for position B. Green indicates OK.

BUC B ONLINE – indicates B side is transmitting the Tx signal to the antenna.

Rx System

General

Communication with the Rx 1+1 Interface Module can be accomplished via any of four interfaces: TCP/IP, RS232, RS485, and Handheld Terminal (HHT). FSK link is also provided for future applications, using the same format as for the IBUC's. The connections, except for the FSK link, can be found on connector J1. These can be connected to with an appropriately configured cable and terminal. FSK link is capable of using FSK signals between the Rx 1+1 Interface Module and modem that are multiplexed on the IFL coax cable.

TCP/IP:

Communication with the Rx 1+1 Interface Module via TCP/IP can be through Telnet (ASCII) or the onboard web server (HTTP). The Rx 1+1 Interface Module uses a static IP addressing structure and does not support DHCP. The Rx 1+1 Interface Module is factory-configured as follows:

IP Address 192.168.1.254
IP Gateway 192.168.1.1
Subnet Mask 255.255.255.0
Telnet Port 23

Note: Your computer should have a static IP address on the same subnet as the Rx 1+1 Interface Module. Using a suitable cable, connect the computer to the Rx 1+1 Interface Module J1 connector. Note: If an Ethernet hub is not used to connect to the Rx 1+1 Interface Module, then a crossover cable must be used. An Ethernet hub will function with a straight connect cable. Please see the attached drawing.

Telnet:

On the host computer activate a command prompt window. Enter Telnet 192.168.1.254 and a cursor should appear on the left of the screen. Type the password command, CPE=1234, and the response will be RX1+1>_. Commands may now be entered to access the Rx 1+1 Interface Module functionality. Please see Command List attached.

Web Server:

On the host computer activate a web browser window. In the address window type HTTP://192.168.1.254 and press enter. Within a few seconds you should see the login screen. On the login screen, enter 1234 in the login box and press the Login button. You will be taken to the Alarm Status page where you can select from the following web pages:

- Network Config
- Alarm Config
- Alarm Status
- Sensor Status
- Alarm Control
- Redundant Control

The “Status” pages enable monitoring of various Rx 1+1 Interface Module parameters. Alarms are color coded with green indicating OK, orange as a warning, and red as an alarm condition.

The “Configuration” pages provide access for changing factory default settings to suit specific site or network requirements. Settings take effect when you press the “Update” button. Note that some changes in configuration will cause a loss of communication with the host computer. It will then be necessary to make the corresponding change in the host computer. For example, here are instructions on changing a unit’s IP address (using the default settings):

Navigate to the “Network Config” page

Change the IP address to something other than 192.168.1.254 (the factory default)

Press “Update”.

Note that IP address changes take effect immediately.

In the host computer web browser type the new address and come back in through the Login page.

Please refer to the screen printouts (Webpages) attached.

RS232:

No configuration of the Rx 1+1 Interface Module is required for proper RS232 operation. Connect a suitable cable to connector J1. The RS232 port uses ASCII protocol and a fixed baud rate of 9600 for communication. On the host computer set the serial port settings to the following: Baud rate to 9600, data bits to 8, parity to none, stop bits to 1, and flow control to none. The Rx 1+1 Interface Module can be accessed using a terminal program on the host computer such as HyperTerminal. Hit enter several times and you should see the "RX1+1>" prompt. Type CPE=1234 and the RX1+1> prompt should return. The Rx 1+1 Interface Module is now ready to accept commands.

Following are two examples, which use the default settings. If you need to reconfigure these settings, this describes the sequence of events:

To configure TCP/IP do the following:

CIA=192.168.1.254	// IP Address
CIG=192.168.1.1	// IP Gateway
CIM=24	// Subnet Mask
CIP=23	// Telnet Port

To configure RS485 do the following:

C4A=1	// RS485 Address
C4D=20	// RS485 Delay
C4R=9600	// RS485 Baud rate

RS485:

Communicating with the Rx 1+1 Interface Module across RS485 uses ASCII protocol.

Communication through a terminal program such as HyperTerminal requires an onboard RS485 card in the host computer. In HyperTerminal type the password command: <0001/CPE=1234 followed by the enter key. Once the < prompt comes back the Rx 1+1 Interface Module is ready to accept commands. In the above example <0001/ is the address of the Rx 1+1 Interface Module followed by the desired command.

If an external box is used to convert RS232 to RS485, then a terminal program will not function. These boxes are designed to work with the RTS/CTS lines manually which a terminal program cannot handle. In these cases, a network management program is required to handle this handshaking requirement.

HANDHELD TERMINAL (HHT):

No Rx 1+1 Interface Module configuration is required to use the HHT. To activate the HHT, connect the supplied cable to the IBUC connector labeled J1 and plug the RJ11 connector into the HHT. Once a flashing cursor is seen in the upper left part of the screen, press the decimal key on the HHT 4 times to activate the HHT. The login screen

will appear. Enter the default password of 1234. Please refer to the Rx 1+1 HHT Menu Tree attached to find how specific functions are accessed through the HHT.

LEDs:

There are seven leds mounted on the Rx 1+1 Interface Module housing to provide visual indications of Rx 1+1 Interface Module status.

1+1 Power – indicates power is supplied to the unit.

Activity – indicates Ethernet activity.

A ONLINE – indicates A side is receiving the Rx signal from the antenna.

A ALARM – Red indicates a Major alarm is present for position A. Green indicates OK.

B ALARM – Red indicates a Major alarm is present for position B. Green indicates OK.

B ONLINE – indicates B side is receiving the Rx signal from the antenna.

NORMAL/EMERGENCY – Red indicates hardware override of the waveguide switch is active. Green indicates the M&C has control of the waveguide switch.

ALARMS:

Note that certain alarms are configurable giving the user the ability to define them as Major or Minor alarms. Major alarms will cause switching.

SWITCHES:

There are two switches (SW1 and SW2) that can be accessed by removing the small cover from the front panel.

SW1 allows the user to do a manual override of the waveguide switch (EMERGENCY mode). Once the switch is toggled to the EMERGENCY position, the user will be able to do the override to position A or B by using the switch SW2 (Momentary switch). Please note that in EMERGENCY mode the M&C doesn't have control of the waveguide switch. To return to NORMAL operation (Redundancy), SW1 has to be toggled back to "NORMAL".

Mechanical Interface – TX redundancy systems are mounted on a mounting plate to facilitate installation. The interface box, IBUC's, and the TX RF switch with associated cables and waveguide are mounted on a single plate. Power supply units are mounted on a similar plate that is meant to be mounted close to the IBUC system. See Chapter 9 for outline drawings of the redundancy mounting system.

RX redundancy systems can be ordered with all components mounted on a single plate. For applications where the RX switch and LNBS are mounted directly to the antenna feed, a separate mounting bracket for the interface box is provided.

Service and Maintenance

General

The Terrasat Redundant Systems are self-contained units that require very little maintenance.

Standard Maintenance

For optimum performance, inspect the mechanics of the system every six months. Clean the antenna feeds as necessary to keep them clear of obstructions and check the cables and connectors for signs of wear, damage or loose connections. Check all fan intakes and exhausts to ensure that they are free and clear of debris.

FAULT ISOLATION

Transceiver Fault Isolation

The information contained in this section should suffice in determining whether a Terrasat Redundant System is faulty. The intent is to determine a "GO" or "NO GO" situation based on alarms indicated through the M&C ports, as well as measuring certain signals using test equipment.

AC Power Problems / Conditioning

In today's electrical environment there are many types of power related problems that prevent proper operation of sensitive electronic equipment. These noise problems or disturbances can be caused by such things as voltage induced by lightning, the switching On/Off of high power electrical equipment, or utility company actions such as power factor correction. Serious problems can arise with the occurrence of transients and spikes causing random errors, or even failure of the PSUI circuitry. Whatever the origin of the transients, they can be classified in two simple categories:

COMMON MODE: This is the noise voltage that appears equally and in phase from each signal conductor to ground.

NORMAL MODE: This is the noise potential between the power line conductors. It adds to and subtracts from the power line sinusoidal voltage wave.

Category A

At the wall outlets (and more than 30 feet from a distribution panel) the typical noise is a 0.5 microsecond rise time up to 6 kV peak, open circuit voltage 100 kHz ring wave with 200-ampere short circuit current capability.

Category B

At the distribution panel one can experience the 100 kHz ringwave above but with 500 ampere current capability and a unidirectional impulse up to 6 kV potential rising in 1.2 microseconds and decaying to half voltage in 50 microseconds. Accompanying this can be a short circuit current up to 3000 amperes rising to peak in 8 microseconds and decaying to half value in 20 microseconds.

To ensure uninterrupted service a line conditioner and/or UPS is recommended based on the expected AC power at the site.

Site Related Problems

VSAT antennas are often fitted on top of buildings. Avoid close proximity to elevator motors, etc. Also ensure that the satellite signal path is free and clear of obstructions.

M&C Checks

When troubleshooting the Redundant Systems the first level of troubleshooting should be to check the status through the M&C ports. Alarms and an alarm history are available. Refer to later in this chapter for specific information when using the RS232, RS485, Ethernet or Handheld Terminal ports.

Power Supply Checks

Before starting the RF troubleshooting first verify that the proper voltages are being supplied to the Tx and Rx Redundant Systems. Input DC Voltage and current consumption data are available from the both M&C. Verify that values are within limits. If M&C is not available, use a multimeter to verify that the appropriate voltages (24VDC or 48 VDC) are present at the IBUC and Rx 1+1 Interface Module. The labeling on the IBUC's has the required voltage (24VDC or 48VDC).

Transmit Power Setting

There have been several cases where the transmit power has been turned up to or near saturation while transmitting a digital carrier. This most likely will result in spectral distortion, i.e., "shoulders", "ears", etc.

When transmitting digital carriers, it is customary to operate the power amplifier system with an Output Back Off (OBO) sufficient to meet the spectral density mask requirements.

TX IF Input Level Verification

If low or no TX output power is detected, start the troubleshooting by checking the input to the Tx Redundant System. Use the following procedures:

- Check the TX Input Level displayed in M&C or disconnect the cable at the IBUC A and B J1 (TX L-band) and use a spectrum analyzer to measure the power level of the L-band signal at the output of the coaxial cable that connects to the IBUC's at J1 (TX L-band). The L-band signal level should be between -20 and -55 dBm. If it is not, check the cable and modem output.
- If the L-band signal is good, check that the 10MHz-reference signal is between $+3$ and -12 dBm and is distortion free. If it is not, check the cable and modem output (or IFU TX OUT).

- If the L-band and 10MHz signals are good check that the DC voltage level is within range. The DC voltage will be on the DC cable that is connected to the IBUC's J3 (DC Input). If it is not, check the PSU's outputs and cables.
- If the L-band, 10MHz and DC voltage signals are good proceed to the Tx Redundancy Output verification.
- Disconnect the spectrum analyzer from the coaxial cable.

Tx Redundancy Output Verification

This check assumes that the L-band, 10MHz and DC inputs are at the correct levels.

- TX Output level is monitored and displayed in the IBUC M&C.
- Alternatively, you may connect a waveguide to coax adapter and a 40dB high power attenuator to the TX waveguide output.
- Measure the TX RF output with the spectrum analyzer connected at the waveguide output. Ensure that the cable loss of the cable being used for the measurement has been taken into account.
- The RF power should be between rated power and rated power -25 dB. If it is not, the IBUC is defective and should be returned to the factory for repair.
- If the IBUC TX RF output measures good, check the waveguide, feedhorn and antenna for proper operation.

Receive L-band Output Verification

If low or no RX output power is detected, start the troubleshooting by checking the output of the LNB's. Use the following procedures:

- Ensure that the 15-24VDC (LNB Bias) is present at the Rx 1+1 Interface Module RX input using a DVM. If it is not, check the cable and Interface.
- Use a spectrum analyzer to ensure that the 10MHz signal is present at the modem RX input. If it is not, check the cable and modem.

Warning; DC power will be present on the cable so the use of a DC block is recommended.

- Connect the Interface to the demodulator by attaching the coaxial cables from the RX L-band OUT (J6) on the Interface to the demodulator RX L-band input port. If the RX level is low check the cable, the feedhorn and antenna for proper operation.

Common Problems

The following common problems or occurrences have been noted during normal troubleshooting:

Supply voltage at IBUC is low or missing

10MHz reference at the IBUC is at the wrong level or missing

10MHz phase noise does not meet the minimum requirements

Antenna is misaligned

Bad OMT and/or antenna

Damaged cables

Antenna on the wrong satellite

TX L-band input level is misadjusted or turned off
Water in the IBUC due to no gasket in the waveguide or a hole in the feed window.
Water in the coax connectors
Incorrect frequency settings

Repair Policy

The Terrasat Redundant Systems are not field repairable.

In the event that a failure has been detected it may be necessary to return the defective unit to the factory. Refer to chapter 1 for returning a defective unit to the factory.

M&C Functions

Description of Operation

The TX and RX redundancy systems are designed to provide an interface for user configuration and control of the systems. In the TX system, the IBUC's monitor status can initiate switching when required. The unit in position B can be commanded to clone itself to the unit in position A. This ensures that IBUC B is configured identically to IBUC A. M&C features available in the IBUC are available via the interface box enabling a single point of control for both IBUC's. Commands and alarms unique to the redundancy systems are built in to the IBUC M&C software.

The interface box includes an Ethernet hub to enable the user to monitor and control both IBUC's in TCP/IP with one Ethernet connection and cable.

For remote operation the Redundant Systems are equipped with a Monitor and Control function. The I/O includes, an FSK modem interface, an RS-232 interface, an RS-485 interface, a handheld terminal, an Ethernet interface, one Multi-function LED, and one alarm relay closure (Form-C).

USER INTERFACES

- 1) **Tx and Rx Systems:** a bank of LED's provide visual indications of Tx 1+1 and Rx 1+1 status.

- 2) **Hand Held Terminal (HHT)** is an optional item that may be used to access the Tx and Rx Systems for local M&C via the M&C ports J1 (IBUC A) and J8 (IBUC B) for Tx Systems and port J1 for Rx Systems. The HHT has a 4 row x 20 column display with 4 function keys (F1-F4), a numeric keypad (0-9), and YES, No, BKSP

(backspace), SPACE, & ENTER keys. Initiate HHT by entering “....” (4 dots), followed by password. The default password is “1234”.

Refer to figure 7-8 for the HHT layout.

The HHT menu consists of a main menu with multiple sub-menus. The sub-menus may be selected by entering the corresponding digit as displayed on the HHT display. To maneuver back to the previous screen simply hit the BKSP (backspace) key. Some screens (i.e. INFO) only display information whereas other screens require user inputs. User input fields are reflected by the corresponding digit and a colon (i.e. 0:) as shown in the HHT Menu Tree (figure 6-2) for Tx systems and the figure 7-9 for Rx systems.

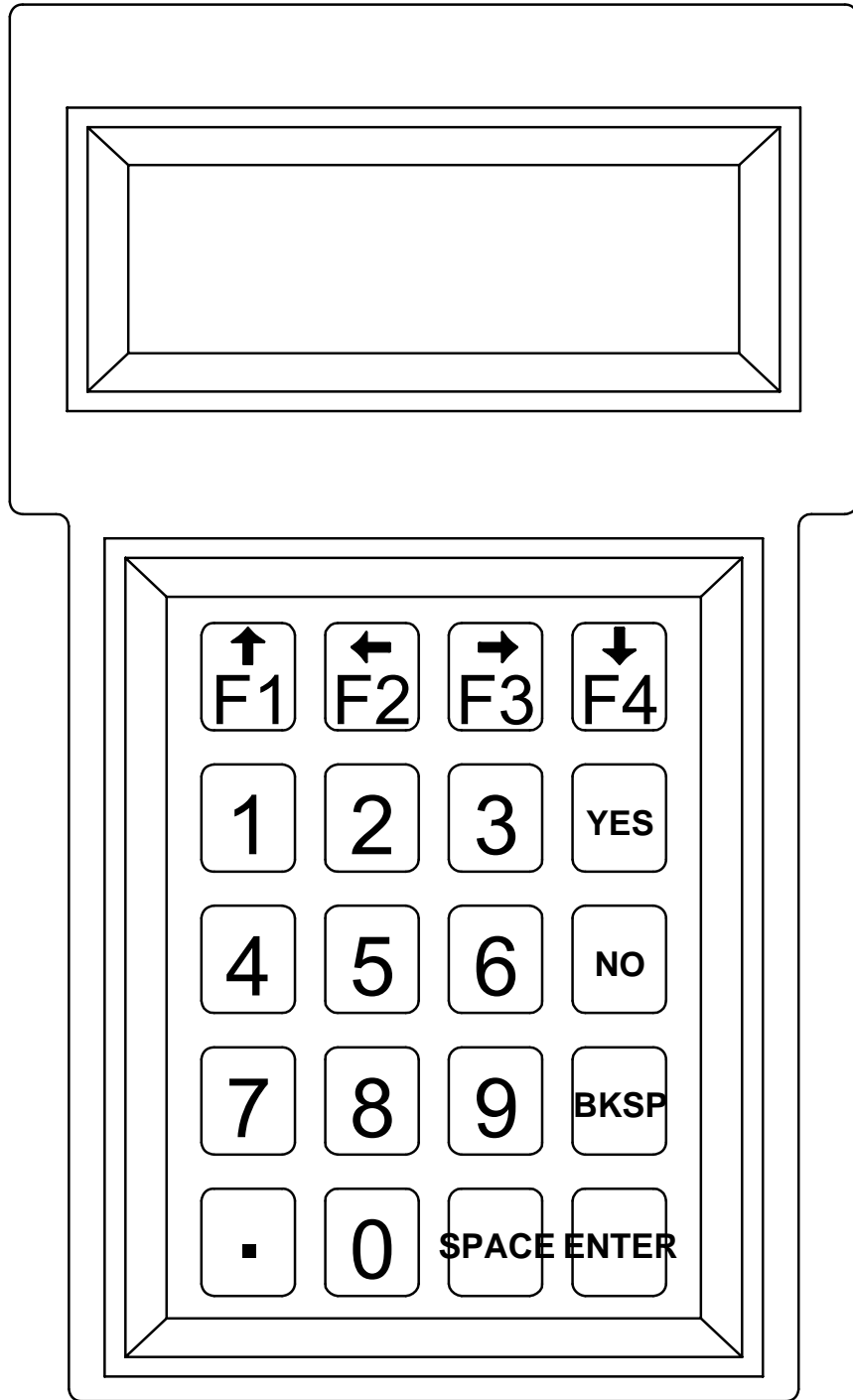

Figure 7-8 IBUC Hand Held Terminal

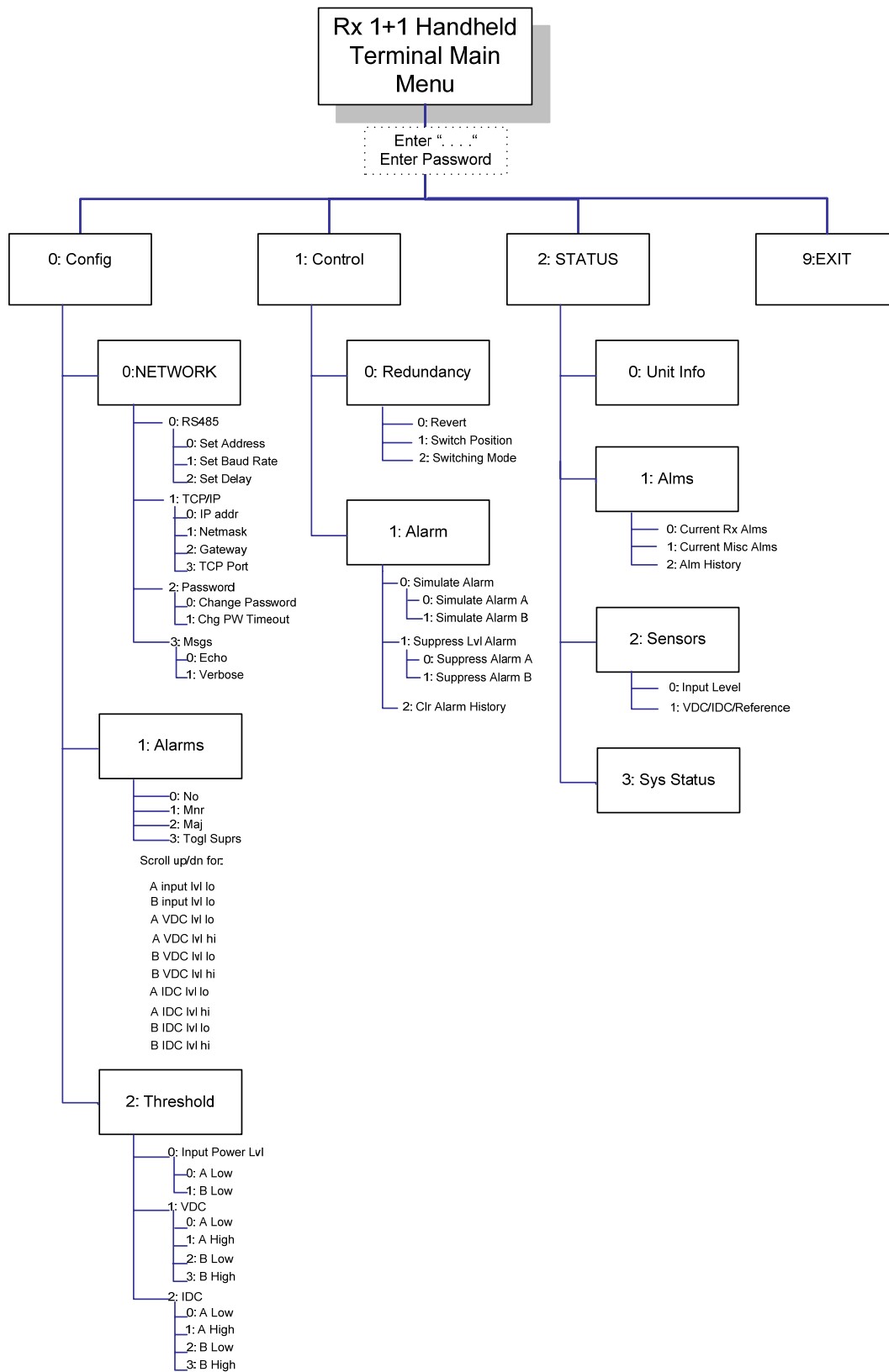

Figure 7-9 RX 1+1 Hand Held Terminal Menu Tree

3) **FSK** multiplexed onto the IF cable by means of an FSK modulated signal. FSK operation for Redundancy commands allows only one mode: ASCII. Commands and values available in ASCII mode (Tx Redundant Systems) are shown in the command set, Table 6.9. FSK and RS-485 are tied together by the Mode of operation (Legacy-binary or ASCII). Once the mode is selected, both will work in the same mode.

See Chapter 6 for FSK Specifications.

4) **RS485** two wire half-duplex which is on a separate cable. There are two modes of operation for RS-485 interface: ASCII mode and Legacy-binary mode. Commands for Redundant Systems are available only in ASCII mode.

RS-485 in ASCII mode:

The RS-485 interface is a standard 2-wire interface (DATA+, DATA-). The baud rate is programmable to 1200, 2400, 4800, 9600, 19200, 38400, 57600 or 115200 Baud. The data is transmitted asynchronously as 8 bits, no parity, 1 stop bit.

Basic protocol:

Start of Packet: < (ASCII code 60; 1 character)

Target Address: (4 characters)

Address De-limiter: / (ASCII code 47; 1 character)

Instruction code: (3 characters)

Code qualifier: = or ? (ASCII code 61 or 63; 1 character)

Optional arguments: (n characters)

End of Packet: Carriage Return (ASCII code 13; 1 character)

Example: <0001/CPE=1234{CR}

Commands and values available in ASCII mode for Tx Redundant Systems are shown in the command set, Table 6.2; for Rx Redundant Systems they are shown in Table 7.16.

5) **TCP/IP** via Ethernet cable:

The Ethernet port is a highly integrated Ethernet Controller which offers an NE2000 compatible adapter with full duplex and power down features. The full-duplex function enables simultaneously transmission and reception on the twisted-pair link to a full-duplex Ethernet switching hub. The Ethernet interface is connected through an isolation transformer and filter.

For the Ethernet interface, the packet is encapsulated in several layers (TCP segment inside of an IP datagram inside of an Ethernet frame). The Ethernet MAC

address is preset at the factory – each IBUC having a unique MAC address. The IP address, network mask, default route, DNS server, and TCP listen port are configurable through the Hand held Terminal interface. The IBUC controller does not support DHCP.

The command set for Tx Redundant Systems RS232, RS485, FSK, TCP/IP and Hand Held Terminal is shown in Table 6.9.

The command set for Rx Redundant Systems RS232, RS485, FSK, TCP/IP and Hand Held Terminal is shown in Table 7.16

Table 7-10 RX 1+1 Command Set

<u>Parameter</u>	<u><value> Valid Values</u> <u>(See Notes Below)</u>	<u>Comments</u>	<u>Command</u>	<u>Default Value</u>	<u>HHT</u> <u>[Note</u> <u>4]</u>	<u>RS-</u> <u>232</u> <u>Port</u>	<u>RS-</u> <u>485</u> <u>Port</u> <u>ASCII</u>	<u>FSK</u> <u>Port</u> <u>ASCII</u>	<u>Telnet</u> <u>Port</u>	<u>Web Page</u>
------------------	---	-----------------	----------------	----------------------	---	---	---	---	------------------------------	-----------------

System Configuration										
Get RS485 Address			C4A?	na	X	X	X	X	X	X
Set RS485 Address	1 to 254	Configures the RS-485 Address. New address takes effect IMMEDIATELY - (i.e. before response is returned).	C4A=<value>	1	X	X	X	X	X	X
Get RS485/FSK Delay			C4D?	na	X	X	X	X	X	X
Set RS485/FSK Delay	1 to 255	Sets the RS485 and FSK Rx/Tx Turnaround delay in Msec.	C4D=<value>	20	X	X	X	X	X	X
Get /RS485 Data Rate			C4R?	na	X	X	X	X	X	X
Set RS485 Data Rate	1200, 2400, 4800, 9600, 19200, 38400, 57600, 115200	Configures the RS-485 baud rate.	C4R=<value>	9600	X	X	X	X	X	X
Get Verbose Messages			C4V?	na	X	X	X	X	X	X
Set Verbose Messages	0 = terse, 1=verbose	Sets the response of the serial and TCP connections to terse (for	C4V=<value>	0	X	X	X	X	X	X

Table 7-10 RX 1+1 Command Set

<u>Parameter</u>	<u><value> Valid Values</u> (See Notes Below)	<u>Comments</u>	<u>Command</u>	<u>Default Value</u>	<u>HHT</u> <u>[Note</u> <u>4]</u>	<u>RS-</u> <u>232</u> <u>Port</u>	<u>RS-</u> <u>485</u> <u>Port</u> <u>ASCII</u>	<u>FSK</u> <u>Port</u> <u>ASCII</u>	<u>Telnet</u> <u>Port</u>	<u>Web Page</u>
		computers to read) or verbose (for people to read).								
Get Alarm Flags		See Table 3 for defined error flags	CAS?	na	X	X	X	X	X	X
Get Alarm Flags (Verbose)			CAS=1	na	X	X	X	X	X	X
Get Model and Serial Number	m,s where m is an ASCII string of up to 19 characters representing the model number and s is an ASCII string of up to 19 characters representing the serial number. (e.g. 310-10801-0001, TE0000000)	Query from firmware Constants	CCM?	na	X	X	X	X	X	X
Get Software Version	n.nn	Query from firmware Constants	CCS?	na	X	X	X	X	X	X
Get IP address			CIA?	na	X	X	X	X	X	X
Set IP address	1.0.0.0 to 223.255.255.254	Sets the TCP IP address of the unit.	CIA=<value>	192.168.1.254	X	X	X	X	X	X
Get IP gateway			CIG?	na	X	X	X	X	X	X
Set IP gateway	1.0.0.0 to 223.255.255.254	Sets the TCP IP address of the	CIG=<value>	192.168.1.1	X	X	X	X	X	X

Table 7-10 RX 1+1 Command Set

<u>Parameter</u>	<u><value> Valid Values</u> <u>(See Notes Below)</u>	<u>Comments</u>	<u>Command</u>	<u>Default Value</u>	<u>HHT</u> <u>[Note</u> <u>4]</u>	<u>RS-</u> <u>232</u> <u>Port</u>	<u>RS-</u> <u>485</u> <u>Port</u> <u>ASCII</u>	<u>FSK</u> <u>Port</u> <u>ASCII</u>	<u>Telnet</u> <u>Port</u>	<u>Web Page</u>
	Must be part of subnet.	default route.								
Get IP netmask			CIM?	na	X	X	X	X	X	X
Set IP netmask	8 to 30	Sets the TCP/IP netmask. (number of 1's in netmask).	CIM=<value>	24	X	X	X	X	X	X
Get TCP Telnet Port number			CIP?	na	X	X	X	X	X	X
Set TCP Telnet Port number	1-65534	Sets the TCP port number for the TCP/IP stack to listen on for incoming telnet connections.	CIP=<value>	23	X	X	X	X	X	X
Get UDP SNMP Port number			CIS?	na	No	X	X	X	X	No
Set UDP SNMP Port number	1-65534	Sets the UDP input port number for the TCP/IP stack to listen on for incoming SNMP packets.	CIS=<value>	160	No	X	X	X	X	No
Get UDP SNMP Trap Port number			CIT?	na	No	X	X	X	X	No
Set UDP SNMP Trap Port number	1-65534	Sets the UDP destination port number for the TCP/IP stack to generate SNMP	CIT=<value>	161	No	X	X	X	X	No

Table 7-10 RX 1+1 Command Set

<u>Parameter</u>	<u><value> Valid Values</u> <u>(See Notes Below)</u>	<u>Comments</u>	<u>Command</u>	<u>Default Value</u>	<u>HHT</u> <u>[Note</u> <u>4]</u>	<u>RS-</u> <u>232</u> <u>Port</u>	<u>RS-</u> <u>485</u> <u>Port</u> <u>ASCII</u>	<u>FSK</u> <u>Port</u> <u>ASCII</u>	<u>Telnet</u> <u>Port</u>	<u>Web Page</u>
		Trap packets on .								
Get info	private label, Model m, SN s, Firmware Ver n.nn, mmm dd yyyy, tt:tt:tt where: private label is set using the CPL command m denotes model number, s denotes the serial number, n.nn is the software version number, mmm dd yyyy is the date of firmware, tt:tt:tt is the time of the firmware,	Query of unit configuration.	COI?	Terrasat Comm., Inc, Model 310-10801-0001 , SN TE0000000, Firmware Ver. n.nn, date, time	X	X	X	X	X	X
Enter Password	00001 - 65535	If superuser password entered, superuser mode is entered. If main password entered, then normal operation is enabled. If read only password entered (1111)	CPE=<value>	na	X	X	X	X	X	X

Table 7-10 RX 1+1 Command Set

<u>Parameter</u>	<u><value> Valid Values</u> <u>(See Notes Below)</u>	<u>Comments</u>	<u>Command</u>	<u>Default Value</u>	<u>HHT</u> <u>[Note</u> <u>4]</u>	<u>RS-</u> <u>232</u> <u>Port</u>	<u>RS-</u> <u>485</u> <u>Port</u> <u>ASCII</u>	<u>FSK</u> <u>Port</u> <u>ASCII</u>	<u>Telnet</u> <u>Port</u>	<u>Web Page</u>
		then read only mode entered.								
Set Password	00001 - 65535	Only sets the main password. Superuser password is function of serial number. Read only password cannot be changed.	CPS=<value>	1234	X	X	X	X	X	X
Get Password Timeout		Returns value of the password timeout.	CPT?	na	X	X	X	X	X	X
Set Password Timeout	0 to 65535 (in minutes)	A zero value indicates the timeout is disabled. Otherwise the system will clear the passwd_recvd flag if a command is received after this amount of inactivity. Every command received updates the timer.	CPT=<value>	0	X	X	X	X	X	X

Table 7-10 RX 1+1 Command Set

<u>Parameter</u>	<u><value> Valid Values</u> <u>(See Notes Below)</u>	<u>Comments</u>	<u>Command</u>	<u>Default Value</u>	<u>HHT</u> <u>[Note</u> <u>4]</u>	<u>RS-</u> <u>232</u> <u>Port</u>	<u>RS-</u> <u>485</u> <u>Port</u> <u>ASCII</u>	<u>FSK</u> <u>Port</u> <u>ASCII</u>	<u>Telnet</u> <u>Port</u>	<u>Web Page</u>
System Reset	<p>czz=2 Reset all vars including ethernet addresses and passwords and reboots. Does not reset model numbers, or serial numbers.</p> <p>czz=1 Reset only int_values[], and reboots.</p> <p>This is handy when that array has changed format, but you really don't want to wipe out the Ethernet info!!</p> <p>czz=0 (or czz) Reboot machine.</p>	Resets all Rx1+1 parameters to the default values.	CZZ	na	No	X	X	X	X	No
Get Echo Enable		Returns state of Echo Enable flag	EKO?	na	X	X	X	X	X	X
Set Echo Enable	1=On or 0=Off	Specifies whether Rx1+1 should echo back results of Set commands, or be discretely silent	EKO=<value>	1	X	X	X	X	X	X
Set Private Label	Any Alpha Numeric String up to 19 characters.	Returns the private label company information (e.g.	CPL=<value>	Terrasat Comm., Inc	No	X	X	X	X	No

Table 7-10 RX 1+1 Command Set

<u>Parameter</u>	<u><value> Valid Values</u> (See Notes Below)	<u>Comments</u>	<u>Command</u>	<u>Default Value</u>	<u>HHT</u> <u>[Note</u> <u>4]</u>	<u>RS-</u> <u>232</u> <u>Port</u>	<u>RS-</u> <u>485</u> <u>Port</u> <u>ASCII</u>	<u>FSK</u> <u>Port</u> <u>ASCII</u>	<u>Telnet</u> <u>Port</u>	<u>Web Page</u>
		Terrasat Inc.)								
Get Minor Alarm Mask	0xNNNN where The bits of NNNN are as follows: bits 15-14 = not used bit 13 = B IDC THRESHOLD HIGH bit 12 = B IDC THRESHOLD LOW bit 11 = A IDC THRESHOLD HIGH bit 10 = A IDC THRESHOLD LOW bit 9 = WAVEGUIDE SWITCH FAULT bit 8 = B VDC THRESHOLD HIGH bit 7 = B VDC THRESHOLD LOW bit 6 = A VDC THRESHOLD HIGH bit 5 = A VDC THRESHOLD LOW bit 4 = 10MHz REFERENCE	Returns the minor alarm flags (hexadecimal)	CM1?	0x01F0	X	X	X	X	X	X
Set Minor Alarm Mask		Sets the Minor alarm flags (hexadecimal is accepted)	CM1=<value>		X	X	X	X	X	X
Get Major Alarm Mask		Returns the Major alarm flags (hexadecimal)	CM2?	0x7E0F	X	X	X	X	X	X
Set Major Alarm Mask		Sets the Major alarm flags (hexadecimal is accepted)	CM2=<value>		X	X	X	X	X	X
Get Alarm Suppressable Mask		Returns the alarm suppressible flags (hexadecimal)	CMS?	0x3DE3	X	X	X	X	X	X
Set Alarm Suppressable Mask		Sets the alarm suppressible flags (hexadecimal is accepted)	CMS=<value>		X	X	X	X	X	X

Table 7-10 RX 1+1 Command Set

<u>Parameter</u>	<u><value> Valid Values</u> <u>(See Notes Below)</u>	<u>Comments</u>	<u>Command</u>	<u>Default Value</u>	<u>HHT</u> <u>[Note</u> <u>4]</u>	<u>RS-</u> <u>232</u> <u>Port</u>	<u>RS-</u> <u>485</u> <u>Port</u> <u>ASCII</u>	<u>FSK</u> <u>Port</u> <u>ASCII</u>	<u>Telnet</u> <u>Port</u>	<u>Web Page</u>
	FAULT bit 3 = B SIMULATED ALARM bit 2 = A SIMULATED ALARM bit 1 = B INPUT THRESHOLD LOW bit 0 = A INPUT THRESHOLD LOW									
Get Web Page Refresh Rate		Returns value of the web page auto refresh variable	CWR?	na	No	X	X	X	X	X
Set Web Page Refresh Rate	0 to 3600 (in seconds)	A zero value indicates refresh is disabled. Otherwise the system will refresh the web page every CWR seconds.	CWR=<value>	0	No	X	X	X	X	X
Disconnect Telnet		Used to disconnect a Telnet session if your or kill a hung Telnet connection.	DCN	na	No	X	X	X	X	No
Backup Mode										
Get Redundancy	0=Revert, 1=NonRevert	Returns the redundancy	BAM?	na	X	X	X	X	X	X

Table 7-10 RX 1+1 Command Set

<u>Parameter</u>	<u><value> Valid Values</u> <u>(See Notes Below)</u>	<u>Comments</u>	<u>Command</u>	<u>Default Value</u>	<u>HHT [Note 4]</u>	<u>RS-232 Port</u>	<u>RS-485 Port ASCII</u>	<u>FSK Port ASCII</u>	<u>Telnet Port</u>	<u>Web Page</u>
Mode		mode.								
Set Redundancy Mode	0=Revert, 1=NonRevert	Sets the redundancy mode of operation. In reverting mode, a switch may occur from A->B or B->A based on the current alarms. In non-reverting mode, a switch from A->B may occur, then stays in the B position unless there is user intervention.	BAM=<value>	0	X	X	X	X	X	X
Get Redundancy Switching Type	0=Manual, 1=Automatic	Gets the redundancy switching type of the Rx1+1.	BSM?	na	X	X	X	X	X	X
Set Redundancy Switching Type	0=Manual, 1=Automatic	Gets the redundancy switching type of the Rx1+1. If switching type is automatic, then the BUC will control the switch as described in BAM. If Manual, then redundancy switching is	BSM=<value>	1	X	X	X	X	X	X

Table 7-10 RX 1+1 Command Set

<u>Parameter</u>	<u><value> Valid Values</u> (See Notes Below)	<u>Comments</u>	<u>Command</u>	<u>Default Value</u>	<u>HHT [Note 4]</u>	<u>RS-232 Port</u>	<u>RS-485 Port ASCII</u>	<u>FSK Port ASCII</u>	<u>Telnet Port</u>	<u>Web Page</u>
		disabled - ie only the user can change the switch.								
Get Switch Position	0=A, 1=B	Returns current redundancy switch position. I.E. If the switch is in position A, then this command will return 0.	BSW?	na	X	X	X	X	X	X
Set Switch Position	0=A, 1=B	Sets the switch to position indicated.	BSW=<value>	na	X	X	X	X	X	X
Get Syst Status	A=Auto or Manual, OnLine or Standby or Faulted B=Auto or Manual, OnLine or Standby or Faulted SWITCH=A or B or Faulted	Returns summary status of A side, B side, and switch.	BST?	na	X	X	X	X	X	X
Receive										
Get Receive Alarm Simulation A			RAS?	na	X	X	X	X	X	X
Set Receive	1=On or 0=Off	Places alarm relay into	RAS=<value>	0	X	X	X	X	X	X

Table 7-10 RX 1+1 Command Set

<u>Parameter</u>	<u><value> Valid Values</u> <u>(See Notes Below)</u>	<u>Comments</u>	<u>Command</u>	<u>Default Value</u>	<u>HHT</u> <u>[Note</u> <u>4]</u>	<u>RS-</u> <u>232</u> <u>Port</u>	<u>RS-</u> <u>485</u> <u>Port</u> <u>ASCII</u>	<u>FSK</u> <u>Port</u> <u>ASCII</u>	<u>Telnet</u> <u>Port</u>	<u>Web Page</u>
Alarm Simulation A		"faulted" state and sets bit in alarm Byte. (See CAS?)								
Get Receive Alarm Simulation B			RBS?	na	X	X	X	X	X	X
Set Receive Alarm Simulation B	1=On or 0=Off	Places alarm relay into "faulted" state and sets bit in alarm Byte. (See CAS?)	RBS=<value>	0	X	X	X	X	X	X
Get Receive Alarm Suppression A		Returns current value Alarm Suppression	RAZ?	na	X	X	X	X	X	X
Set Receive Alarm Suppression A	1=On or 0=Off	Suppresses all Level Alarms. All other alarms are still operational	RAZ=<value>	0	X	X	X	X	X	X
Get Receive Alarm Suppression B		Returns current value Alarm Suppression	RBZ?	na	X	X	X	X	X	X
Set Receive Alarm Suppression B	1=On or 0=Off	Suppresses all Level Alarms. All other alarms are still operational	RBZ=<value>	0	X	X	X	X	X	X

Table 7-10 RX 1+1 Command Set

<u>Parameter</u>	<u><value> Valid Values</u> (See Notes Below)	<u>Comments</u>	<u>Command</u>	<u>Default Value</u>	<u>HHT</u> <u>[Note</u> <u>4]</u>	<u>RS-</u> <u>232</u> <u>Port</u>	<u>RS-</u> <u>485</u> <u>Port</u> <u>ASCII</u>	<u>FSK</u> <u>Port</u> <u>ASCII</u>	<u>Telnet</u> <u>Port</u>	<u>Web Page</u>
Get Input Receive Alarm Low Threshold		Returns Input low power level threshold	RAL?	na	X	X	X	X	X	X
Set Input Receive Alarm Low Threshold	5.0 to -40.0 dBm (0.1 dB steps)	Sets Input low power Level threshold. (same as RBH except low threshold)	RAL=<value>	-40	X+-	X	X	X	X	X
Get Input Receive Alarm Low Threshold		Returns Input low power level threshold	RBL?	na	X	X	X	X	X	X
Set Input Receive Alarm Low Threshold	5.0 to -40.0 dBm (0.1 dB steps)	Sets Input low power Level threshold. (same as RBH except low threshold)	RBL=<value>	-40	X+-	X	X	X	X	X
Get Input Power Sensor Reading		Returns the current input power level in dBm.	RDT?	na	X	X	X	X	X	X
Get 10MHz detector	1=10MHz within Range, 0=10MHz out of range	Returns the state of the TEN_MHZ_DET line	C10?	na	X	X	X	X	X	X
Get VDC detector	10.0 to 25.0 volts DC	Returns the VDC_DET voltage	CVD?	na	X	X	X	X	X	X
Get IDC Detector	100 to 600 ma	Returns the IDC_DET voltage	CID?	na	X	X	X	X	X	X
Get Voltage	10.0 to 25.0 volts DC (Must be less	Returns the low voltage	VAL?		X	X	X	X	X	X

Table 7-10 RX 1+1 Command Set

<u>Parameter</u>	<u><value> Valid Values</u> <u>(See Notes Below)</u>	<u>Comments</u>	<u>Command</u>	<u>Default Value</u>	<u>HHT</u> <u>[Note</u> <u>4]</u>	<u>RS-</u> <u>232</u> <u>Port</u>	<u>RS-</u> <u>485</u> <u>Port</u> <u>ASCII</u>	<u>FSK</u> <u>Port</u> <u>ASCII</u>	<u>Telnet</u> <u>Port</u>	<u>Web Page</u>
Alarm Low Threshold A	than High Threshold)	threshold for the A side								
Set Voltage Alarm Low Threshold A	10.0 to 25.0 volts DC (Must be less than High Threshold)	Sets the low voltage threshold for the A side	VAL=<value>	15	X	X	X	X	X	X
Get Voltage Alarm Low Threshold B	10.0 to 25.0 volts DC (Must be less than High Threshold)	Returns the low voltage threshold for the B side	VBL?		X	X	X	X	X	X
Set Voltage Alarm Low Threshold B	10.0 to 25.0 volts DC (Must be less than High Threshold)	Sets the low voltage threshold for the B side	VBL=<value>	15	X	X	X	X	X	X
Get Voltage Alarm High Threshold A	10.0 to 25.0 volts DC (Must be greater than Low Threshold)	Returns the high voltage threshold for the A side	VAH?		X	X	X	X	X	X
Set Voltage Alarm High Threshold A	10.0 to 25.0 volts DC (Must be greater than Low Threshold)	Sets the high voltage threshold for the A side	VAH=<value>	24	X	X	X	X	X	X
Get Voltage Alarm High Threshold B	10.0 to 25.0 volts DC (Must be greater than Low Threshold)	Returns the high voltage threshold for the B side	VBH?		X	X	X	X	X	X
Set Voltage Alarm High Threshold B	10.0 to 25.0 volts DC (Must be greater than Low Threshold)	Sets the high voltage threshold for the B side	VBH=<value>	24	X	X	X	X	X	X
Get Current Alarm Low Threshold A	100 to 600 ma (Must be less than the High Threshold)	Returns the low voltage threshold for the A side	IAL?		X	X	X	X	X	X
Set	100 to 600 ma	Sets the low	IAL=<value>	250	X	X	X	X	X	X

Table 7-10 RX 1+1 Command Set

<u>Parameter</u>	<u><value> Valid Values</u> <u>(See Notes Below)</u>	<u>Comments</u>	<u>Command</u>	<u>Default Value</u>	<u>HHT</u> <u>[Note</u> <u>4]</u>	<u>RS-</u> <u>232</u> <u>Port</u>	<u>RS-</u> <u>485</u> <u>Port</u> <u>ASCII</u>	<u>FSK</u> <u>Port</u> <u>ASCII</u>	<u>Telnet</u> <u>Port</u>	<u>Web Page</u>
Current Alarm Low Threshold A	(Must be less than the High Threshold)	current threshold for the A side								
Get Current Alarm Low Threshold B	100 to 600 ma (Must be less than the High Threshold)	Returns the low current threshold for the B side	IBL?		X	X	X	X	X	X
Set Current Alarm Low Threshold B	100 to 600 ma (Must be less than the High Threshold)	Sets the low current threshold for the B side	IBL=<value>	250	X	X	X	X	X	X
Get Current Alarm High Threshold A	100 to 600 ma (Must be greater than the Low Threshold)	Returns the high current threshold for the A side	IAH?		X	X	X	X	X	X
Set Current Alarm High Threshold A	100 to 600 ma (Must be greater than the Low Threshold)	Sets the high voltage current for the A side	IAH=<value>	500	X	X	X	X	X	X
Get Current Alarm High Threshold B	100 to 600 ma (Must be greater than the Low Threshold)	Returns the high voltage current for the B side	IBH?		X	X	X	X	X	X
Set Current Alarm High Threshold B	100 to 600 ma (Must be greater than the Low Threshold)	Sets the high voltage current for the B side	IBH=<value>	500	X	X	X	X	X	X
Alarm/Temp Log History										
Monitor Alarm History	Alarm Flag, CR, LF for the last (up to) 100 alarms in order as they occurred.	Returns an ASCII string for each record in history. String format is 0xLLLL where LL is the	AHI?	na	X	X	X	X	X	X

Table 7-10 RX 1+1 Command Set

<u>Parameter</u>	<u><value> Valid Values</u> <u>(See Notes Below)</u>	<u>Comments</u>	<u>Command</u>	<u>Default Value</u>	<u>HHT</u> <u>[Note</u> <u>4]</u>	<u>RS-</u> <u>232</u> <u>Port</u>	<u>RS-</u> <u>485</u> <u>Port</u> <u>ASCII</u>	<u>FSK</u> <u>Port</u> <u>ASCII</u>	<u>Telnet</u> <u>Port</u>	<u>Web Page</u>
		hexadecimal representation of the flag for the alarm. (See note 7 and Table 3)								
Clear Alarm History	none	Clears alarm buffer.	AHZ	na	X	X	X	X	X	X

Table 7-11: Alarm flags

Receive flags	
0x0001	Rx A IF Input Low Level Alarm
0x0002	Rx B IF Input Low Level Alarm
0x0004	Rx A Simulated Fault
0x0008	Rx B Simulated Fault
0x0010	10 MHz Reference Alarm
0x0020	VDC A Low Level Alarm
0x0040	VDC A High Level Alarm
0x0080	VDC B Low Level Alarm
0x0100	VDC B High Level Alarm
0x0200	Waveguide Switch Fault
0x0400	IDC A Low Level Alarm
0x0800	IDC A High Level Alarm
0x1000	IDC B Low Level Alarm
0x2000	IDC B High Level Alarm
0x4000	Emergency Override Switch Active
0x8000	Not Used

Misc flags	
0x0001	Error-log pointers corrupted
0x0002	Fault in restoring config data
0x0004	Ethernet Download
0x0008	Serial Download
0x0010	Reboot

6) M&C using TCP/IP is displayed in embedded web pages. The user connects to the Redundant System M&C and enters one of the IBUC IP address through a web browser (for Tx Redundancy) or the Rx 1+1 Interface Module IP address (for Rx Redundancy). This will bring up a login page. After login, the operator has a choice of a few web pages with monitoring, control and alarm information. For Tx Redundant Systems you'll see a "split screen" (IBUC A and IBUC B) with web pages similar to the ones for Single IBUC Systems (see Chapter 6). A new page is going to show only for Redundant Systems, the Redundant Config page (see below):

Tx Redundant Systems

Redundant Config page:

This page allows the operator to access commands related to the Redundant System

The screenshot displays the 'IBUC M&C Webpage' interface. At the top left is the Terrasat Communications, Inc. logo. The page title is 'IBUC M&C Webpage'. The main content is split into two panels: 'IBUC A Master' and 'IBUC B Slave'. Each panel has a 'Menu Options' list with 'Redundant Config' highlighted in a dark blue box. Below the menu is a timestamp: 'This page generated: Wed Mar 29 14:41:11 2006' for the master and 'Wed Mar 29 14:46:26 2006' for the slave. A 'Logout Refresh' link is present in each panel. At the bottom of each panel is a table of system information.

IBUC A Master		IBUC B Slave	
Serial Number	TE5010945	Serial Number	TE5010946
Model Number	IBUC058064-148020	Model Number	IBUC058064-148020
Firmware Version	FW IBUC v0.85, Wed Mar 1 2006 16:47:05	Firmware Version	FW IBUC v0.85, Wed Mar 1 2006 16:47:05
Power Class	20 W	Power Class	20 W

Figure 7-10 Redundant Config page

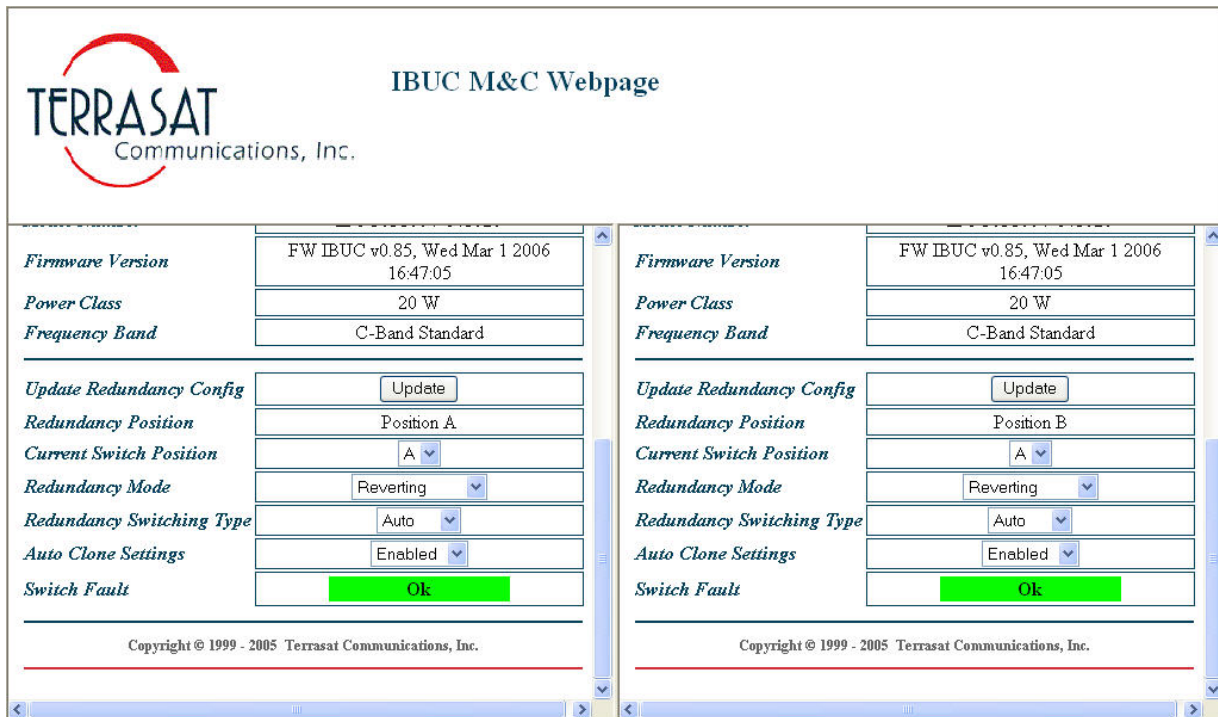

Refer to Table 6.9 IBUC M&C Command Set for information regarding parameters and valid values.

Rx Redundant Systems

Login page:

Type the password in the box and click the Login button to Login. The default value is 1234.



Figure 7-11 Login page

Network Config page:

This page allows the operator to configure the interfaces (TCP/IP or RS-485/FSK). It also allows the operator to set the Webserver refresh rate. When set to 0 sec, the Webpage will **not** be refreshed.



RX1+1 M&C Webpage

Menu Options:

- Network Config**
- Alarm Config
- Threshold Config
- Alarm Status
- Sensor Status
- Alarm Control
- Redundant Control

This page generated: Wed Mar 29 14:56:42 2006

[Logout Refresh](#)

<i>Serial Number</i>	TE6010006
<i>Model Number</i>	310-10801-0001
<i>Firmware Version</i>	Firmware Ver. 0.04, Mon Feb 13 2006 10:58:50

<i>IP Address</i>	192.168.1.254
<i>IP Subnet Mask</i>	255.255.255.0
<i>Gateway Address</i>	192.168.1.1
<i>Telnet TCP Port</i>	23
<i>Update IP Settings</i>	<input type="button" value="Update"/>

<i>RS-485/FSK Address</i>	1
<i>Baud Rate</i>	9600 <input type="button" value="v"/>
<i>RS-485/FSK Delay</i>	20
<i>Update Serial Settings</i>	<input type="button" value="Update"/>

<i>System Password</i>	
<i>Password Timeout</i>	0 min
<i>Update Password Settings</i>	<input type="button" value="Update"/>

<i>Verbose Messages</i>	Disabled <input type="button" value="v"/>
<i>Echo</i>	Enabled <input type="button" value="v"/>
<i>Webserver Auto Refresh</i>	0 sec
<i>Update Message Settings</i>	<input type="button" value="Update"/>

Copyright © 1999 - 2004 Terrasat Communications, Inc.

Figure 7-12 Network Config page

Refer to Table 7.10 Rx 1+1 Command Set for information regarding parameters and valid values.

Alarm Config page:

This page allows the operator to configure the alarms as Minor, Major or None. Major alarms are the ones that cause a summary alarm (relay closure) with the Form-C relay. This is particularly important when operating in redundancy. Summary alarms are the ones that will cause switchovers. It also allows operator to configure alarms as suppressible. Suppressible alarms are the ones that will be suppressed when enabling “Suppress Rx Fault” (see Alarm Control page).



RX1+1 M&C Webpage

Menu Options:

- Network Config
- Alarm Config
- Threshold Config
- Alarm Status
- Sensor Status
- Alarm Control
- Redundant Control

This page generated: Wed Mar 29 14:57:16 2006

[Logout](#) [Refresh](#)

<i>Serial Number</i>	TE6010006
<i>Model Number</i>	310-10801-0001
<i>Firmware Version</i>	Firmware Ver. 0.04, Mon Feb 13 2006 10:58:50

	<i>A Side</i>	<i>B Side</i>
<i>Input Low Threshold</i>	MAJOR ▾	MAJOR ▾
<i>VDC High Threshold</i>	MINOR ▾	MINOR ▾
<i>VDC Low Threshold</i>	MINOR ▾	MINOR ▾
<i>IDC High Threshold</i>	MAJOR ▾	MAJOR ▾
<i>IDC Low Threshold</i>	MAJOR ▾	MAJOR ▾
<i>Update Alarm Flags</i>	<input type="button" value="Update"/>	

	<i>A Side</i>	<i>B Side</i>
<i>Input Low Threshold Suppressible</i>	Enabled ▾	Enabled ▾
<i>VDC High Threshold Suppressible</i>	Enabled ▾	Enabled ▾
<i>VDC Low Threshold Suppressible</i>	Enabled ▾	Enabled ▾
<i>IDC High Threshold Suppressible</i>	Enabled ▾	Enabled ▾
<i>IDC Low Threshold Suppressible</i>	Enabled ▾	Enabled ▾
<i>Update Alarm Flags</i>	<input type="button" value="Update"/>	

Copyright © 1999 - 2004 Terrasat Communications, Inc.

Figure 7-13 Alarm Config page

Refer to Table 7.10 Rx 1+1 Command Set for information regarding parameters and valid values.

Threshold Config page:

It allows operator to set the threshold of variables that are being monitored for alarm purposes.



RX1+1 M&C Webpage

Menu Options:

- [Network Config](#)
- [Alarm Config](#)
- [Threshold Config](#)
- [Alarm Status](#)
- [Sensor Status](#)
- [Alarm Control](#)
- [Redundant Control](#)

This page generated: Wed Mar 29 14:59:23 2006

[Logout](#) [Refresh](#)

<i>Serial Number</i>	TE6010006
<i>Model Number</i>	310-10801-0001
<i>Firmware Version</i>	Firmware Ver. 0.04, Mon Feb 13 2006 10:58:50

	<i>A Side</i>		<i>B Side</i>	
<i>Input Low Threshold</i>	-40.00	dBm	-40.00	dBm
<i>VDC High Threshold</i>	25.00	V	25.00	V
<i>VDC Low Threshold</i>	15.00	V	15.00	V
<i>IDC High Threshold</i>	500	mA	500	mA
<i>IDC Low Threshold</i>	250	mA	250	mA
<i>Update Threshold Settings</i>	<input type="button" value="Update"/>			

Copyright © 1999 - 2004 Terrasat Communications, Inc.

Figure 7-14 Threshold Config page

Refer to Table 7.10 Rx 1+1 Command Set for information regarding parameters and valid values.

Alarm Status page:

This page allows the operator to verify the status of the unit. The green background shows that the parameter is OK. Minor faults will have an orange background and major faults will have a red background. At the bottom of the page the operator will be able to access the Alarm History log and clear it by clicking the clear button.



RX1+1 M&C Webpage

Menu Options:
[Network Config](#)
[Alarm Config](#)
[Threshold Config](#)
[Alarm Status](#)
[Sensor Status](#)
[Alarm Control](#)
[Redundant Control](#)

This page generated: Wed Mar 29 15:00:04 2006

[Logout](#) [Refresh](#)

<i>Serial Number</i>	TE6010006
<i>Model Number</i>	310-10801-0001
<i>Firmware Version</i>	Firmware Ver. 0.04, Mon Feb 13 2006 10:58:50

	<i>A Side</i>	<i>B Side</i>
<i>Input Low Threshold</i>	Ok	Ok
<i>Simulate RX Fault</i>	Disabled	Disabled
<i>VDC Low Threshold</i>	Ok	Ok
<i>VDC High Threshold</i>	Ok	Ok
<i>IDC Low Threshold</i>	Ok	Ok
<i>IDC High Threshold</i>	Ok	Ok
<i>10 MHz Detector</i>	Ok	
<i>Switch Fault</i>	Ok	
<i>Emergency Override Switch</i>	Disabled	

Alarm History

Copyright © 1999 - 2004 Terrasat Communications, Inc.

Figure 7-15 Alarm Status page

Refer to Table 7.10 Rx 1+1 Command Set for information regarding parameters and valid values.

Sensor Status page:

This page allows the operator to verify the Input Composite Level, the LNB Supply Voltage and the LNB current consumption.



TERRASAT
Communications, Inc.

RX1+1 M&C Webpage

Menu Options:
Network Config
Alarm Config
Threshold Config
Alarm Status
Sensor Status
Alarm Control
Redundant Control

This page generated: Wed Mar 29 15:00:33 2006

[Logout](#) [Refresh](#)

<i>Serial Number</i>	TE6010006	
<i>Model Number</i>	310-10801-0001	
<i>Firmware Version</i>	Firmware Ver. 0.04, Mon Feb 13 2006 10:58:50	

	<i>A Side</i>	<i>B Side</i>
<i>Input Composite Power Level</i>	-35.84 dBm	-30.47 dBm
<i>Supply Voltage</i>	17.1 V	17.3 V
<i>Current Consumption</i>	368 mA	381 mA

Copyright © 1999 - 2004 Terrasat Communications, Inc.

Figure 7-16 Sensor Status page

Refer to Table 7.10 Rx 1+1 Command Set for information regarding parameters and valid values.

Alarm Control page:

This page allows operator to Simulate and Suppress alarms.

The screenshot shows the 'RX1+1 M&C Webpage' interface. On the left is the Terrasat Communications, Inc. logo. The main heading is 'RX1+1 M&C Webpage'. Below it is a 'Menu Options' list: Network Config, Alarm Config, Threshold Config, Alarm Status, Sensor Status, **Alarm Control** (highlighted), and Redundant Control. A timestamp reads 'This page generated: Wed Mar 29 15:01:09 2006'. A 'Logout Refresh' link is present. A table displays system information: Serial Number (TE6010006), Model Number (310-10801-0001), and Firmware Version (Firmware Ver. 0.04, Mon Feb 13 2006 10:58:50). Below the table are controls for 'Simulate RX Fault' and 'Suppress RX Fault', each with 'A Side' and 'B Side' dropdown menus set to 'Disabled'. An 'Update Alarm Settings' button is also present. The footer contains the copyright notice: 'Copyright © 1999 - 2004 Terrasat Communications, Inc.'

Figure 7-17 Alarm Control page

Refer to Table 7.10 Rx 1+1 Command Set for information regarding parameters and valid values.

Redundant Control page:

This page allows the operator to access commands related to the Redundant System



RX1+1 M&C Webpage

Menu Options:

- Network Config
- Alarm Config
- Threshold Config
- Alarm Status
- Sensor Status
- Alarm Control
- Redundant Control**

This page generated: Wed Mar 29 15:01:36 2006

[Logout](#) [Refresh](#)

Serial Number	TE6010006
Model Number	310-10801-0001
Firmware Version	Firmware Ver. 0.04, Mon Feb 13 2006 10:58:50

Current Switch Position	B
Redundancy Mode	Reverting
Redundancy Switching Type	Auto
Update Redundancy Config	Update

Copyright © 1999 - 2004 Terrasat Communications, Inc.

Figure 7-18 Redundant Control page

Refer to Table 7.10 Rx 1+1 Command Set for information regarding parameters and valid values.

Chapter 8 Glossary

Glossary of Terms

1RU	One Rack Unit (1.75")
ATP	Acceptance Test Procedure
AGC	Automatic Gain Control
BUC	Block UpConverter
°C	Degrees Celsius
CW	Continuous Wave
CSM	Continuous Signal Mode
dB	Decibel
dBc	Decibel Below Carrier
dBm	Decibel referenced to 1 milliwatt
dB/oct	Decibel per Octave
EMC	ElectroMagnetic Compatibility
EMI	ElectroMagnetic Interference
ERM	<u>E</u> lectromagnetic Compatibility and <u>R</u> adio Spectrum <u>M</u> atters
fr	Frequency
FSK	Frequency Shift Keying
FSS	Fixed Satellite Services
g	Gravity
GHz	Gigahertz

GUI	Graphical User Interface
HPC	High Power Converter
Hz	Hertz
IDU	Indoor Unit
IF	Intermediate Frequency
IFU	Interface Unit
IFL	Interfacility Link
I/O	Input/Output
IP	Internet Provider
°K	Degrees Kelvin
kg	Kilogram
LNB	Low Noise BlockConverter
LO	Local Oscillator
M&C	Monitor and Control
MCPC	Multi Carrier Per Channel
MHz	Megahertz
ms	Millisecond
max	Maximum
min	Minimum
MUC	Microwave UpConverter
ns	Nanosecond
ODU	OutDoor Unit
P1dB	Power at the 1dB Compression Point
PLDRO	Phase Locked Dielectric Resonator Oscillator

PLLNBC	Phase Locked Low Noise Block Converter
PLO	Phase Locked Oscillator
p-p	Peak to Peak
PSU	Power Supply Unit
Pwr	Power
QTP	Qualification Test Procedure
RF	Radio Frequency
RH	Relative Humidity
RMS	Root Mean Square
RTC	Real Time Clock
RX	Receive
s	Second
SCPC	Single Carrier Per Channel
SNG	Satellite News Gathering
SSB	Single Side Band
SSPA	Solid State Power Amplifier
TRF	Transmit Reject Filter
TX	Transmit
UPS	Uninterruptible Power Supply
UPC	Upconverter
μs	Microsecond
VSAT	Very Small Aperture Terminal
VDC	Volts direct current

VSWR Voltage Standing Wave Ratio

W Watt

WG Waveguide